



*An Online CPD Course
brought to you by
CEDengineering.ca*

Steam System Basics and Energy Efficiency

Course No: D06-004
Credit: 6 PDH

A. Bhatia



Continuing Education and Development, Inc.

P: (877) 322-5800
info@cedengineering.ca

STEAM SYSTEM BASICS AND ENERGY EFFICIENCY

Overview

Steam, hot water, and hot air are three heating media commonly used in many industries. However, steam has several advantages compared to hot air and hot water. These advantages include:

- a. The heat carrying capacity of steam is much greater than air or water
- b. Steam provides its own motive force
- c. Steam provides heat at a constant temperature

To illustrate these advantages, consider the quantities of air, hot water and steam required to transfer 1,000,000 Btu/hr of heat to a process. If 100 psig steam were condensed in a heat exchanger, the mass flow rate of steam required to transfer 1,000,000 Btu/hr of heat would be about:

$$m_{\text{Steam}} = \frac{Q}{hfg} = \frac{1,000,000 \text{ Btu/hr}}{881 \text{ Btu/lb}} = 1,135 \text{ lb/hr}$$

Where,

- Q is the heat transfer to a process in Btu/h
- hfg is specific heat of evaporation. It represents the enthalpy difference between gas and fluid, and it tells how much heat is needed to change 1 lb of boiling water to steam. It is expressed as $hfg = hg - hf$, where hf is the specific enthalpy of the saturated fluid and hg is the specific enthalpy of the saturated gas/vapor under the same pressure. The value of hfg @100psig pressure is 881 Btu/lb.

Water

If the temperature difference of hot water across heat exchanger is 100°F, the mass flowrate of water to transfer the same amount of heat would be about nine times as much as steam:

$$m_{\text{Water}} = \frac{Q}{(cp \times \Delta t)} = \frac{1,000,000 \text{ Btu/hr}}{(1 \text{ Btu/lb } ^\circ\text{F} \times 100^\circ\text{F})} = 10,000 \text{ lb/hr}$$

Where,

- Q is the heat transfer to a process in Btu/h
- Cp is the specific heat of water = 1 Btu/lb-°F
- Δt is the temperature difference across the heat exchanger in °F

Air

If the temperature of hot air is dropped by 100°F as it passed through a heat exchanger, the mass flow rate of air to transfer the same amount of heat would be about 36 times as much as steam:

$$m_{Air} = \frac{Q}{(c_p \times \Delta t)} = \frac{1,000,000 \text{ Btu/hr}}{(0.24 \text{ Btu/lb } ^\circ\text{F} \times 100^\circ\text{F})} = 41,666 \text{ lb/hr}$$

Where,

- Q is the heat transfer to a process in Btu/h
- Cp is the specific heat of the air (0.24 Btu/lb-°F). It takes 0.24 Btu of heat to change the temperature of one pound of air by one-degree F.
- Δt is the temperature difference across the heat exchanger in °F

The higher flow rates required by water and air require pipes and ducts with larger diameters than steam pipes, which increases first cost and heat loss. In addition, air and water do not propel themselves. Thus, hot air and water distribution systems require fans or pumps, whereas the steam distribution system doesn't require any additional propulsion for outgoing steam and a very small pumping system may be required for returning the condensate to the boiler.

Finally, because steam condenses at a constant temperature, 100-psig steam could heat a process stream to a maximum temperature of 338°F which is the temperature of the steam. On the other hand, the temperature of the water and air decrease as heat is transferred; thus, if the heat in these examples was delivered by a cross-flow heat exchanger, the maximum temperature of the process stream would be 100°F less than the incoming temperature of the air or water. Because of these advantages, steam is the most widely used heat-carrying medium in the process industry.

Delivering the best outcomes for your business requires a whole-system approach not only to the steam generation plant but also steam distribution and use. This course offers step-by-step solutions to help you identify the opportunities to implement best practice to achieve energy efficiency of your steam system.

STEAM SYSTEM BASICS AND ENERGY EFFICIENCY

CONTENTS

1.0. CHAPTER – 1: DESIGN OF STEAM SYSTEMS

- 1.1 Steam Systems
- 1.2 Steps in Designing Steam System
- 1.3 Energy Units and Fuel Properties

2.0. CHAPTER - 2: SYSTEM EQUIPMENT AND COMPONENTS

- 2.1 Steam Generation Equipment
- 2.2 Steam Distribution Components
- 2.3 Steam Utilization at End-User
- 2.4 Controls and Instrumentation

3.0. CHAPTER - 3: FUNDAMENTALS OF COMBUSTION

- 3.1 The Fundamentals of Good Combustion
- 3.2 Combustion Monitoring
- 3.3 Combustion Flue Gas Analyzers
- 3.4 Understanding Combustion Efficiency

4.0. CHAPTER - 4: PERFORMANCE EVALUATION OF A BOILER

- 4.1 Industry Recognized Efficiency Test Standards
- 4.2 Direct Method for Estimating Boiler Efficiency
- 4.3 Indirect Method for Estimating Boiler Efficiency
- 4.4 Heat Losses in Boiler: Calculation and Formulas
- 4.5 Measurements Required for Performance Assessment Testing
- 4.6 Measuring Instruments

5.0. CHAPTER - 5: MEASURES TO REDUCE STACK LOSSES

- 5.1 Factors Affecting Stack Losses
- 5.2 Measures to Reduce Stack Losses

- 5.3 Efficiency Tip # 1: Preheat Boiler Feedwater with Economizer
- 5.4 Efficiency Tip # 2: Install Condensing Economizers
- 5.5 Efficiency Tip # 3: Preheat Combustion Air with Preheater
- 5.6 Efficiency Tip # 4: Regulate Excess Air
- 5.7 Efficiency Tip # 5: Upgrade Boilers with Energy-Efficient Power Burners
- 5.8 Efficiency Tip # 6: Equip Burner with Modulating Controls for Precise Air Fuel Ratio
- 5.9 Efficiency Tip # 7: Reduce Air Infiltration
- 5.10 Efficiency Tip # 8: Variable Speed Control for Fans, Blowers, and Pumps
- 5.11 Efficiency Tip # 9: Clean Boiler Heat Surfaces
- 5.12 Efficiency Tip # 10: Optimize Boiler Loading
- 5.13 Efficiency Tip # 11: Optimize Deaerator Operations
- 5.14 Efficiency Tip # 12: Investigate Fuel Switching

6.0. CHAPTER - 6: MEASURES TO REDUCE BLOWDOWN LOSSES

- 6.1 Why the boiler must blowdown?
- 6.2 Efficiency Tip # 1: Improve Water Treatment Process
- 6.1 Efficiency Tip # 2: Install Automatic Blowdown Controller
- 6.2 Efficiency Tip # 3: Recover Waste Heat from Blowdown

7.0. CHAPTER - 7: MEASURES TO IMPROVE STEAM DISTRIBUTION EFFICIENCY

- 7.1 Efficiency Tip # 1 Optimize Boiler Steam Pressure
- 7.2 Efficiency Tip # 2 Reducing the Work done by Steam
- 7.3 Efficiency Tip # 3 Optimize Steam Piping Design
- 7.4 Efficiency Tip # 4 Adopting Good Layout Practices
- 7.5 Efficiency Tip # 5: Repair Steam Leaks
- 7.6 Efficiency Tip # 6: Minimize Vented Steam
- 7.7 Efficiency Tip # 7: Insulate Steam Piping, Valves, Fittings, and Vessels
- 7.8 Efficiency Tip # 8: Isolate Steam from Unused Lines

7.9 Efficiency Tip # 9: Drain Condensate from Steam Distribution

7.10 Efficiency Tip # 10: Switch from Steam to Air Atomization

7.11 Efficiency Tip # 11: Providing Dry Steam for the Process

8.0. CHAPTER - 8: MEASURES TO IMPROVE STEAM END-USE EFFICIENCY

8.1 Condensate Recovery

8.2 Steam Traps

8.3 Efficiency Tip # 1: Right Application of Steam Traps

8.4 Efficiency Tip # 2: Implement an Effective Steam-Trap Management

8.5 Efficiency Tip # 3: Maximize Thermal Energy of Condensate Recovery

8.6 Efficiency Tip # 4: Utilizing Low Pressure Flash Steam

8.7 Efficiency Tip # 5: Use Flash Steam in lieu of throttling High Pressure Steam

8.8 Efficiency Tip # 6: Cover Heated Open Vessels

1.0. CHAPTER – 1: DESIGN OF STEAM SYSTEMS

Several important factors should be considered when choosing steam as a heating media. The basic questions include:

- Why is steam used (for what purpose)?
- How is it generated?
- How is it used (by what means)?
- How is it distributed?
- How does the steam recovery work?
- Could steam in one or more processes be replaced?

1.1 Steam Systems

Basically, any generic steam system for an industrial plant will have four major subsystems:

- Generation
- Distribution
- End-use
- Condensate recovery

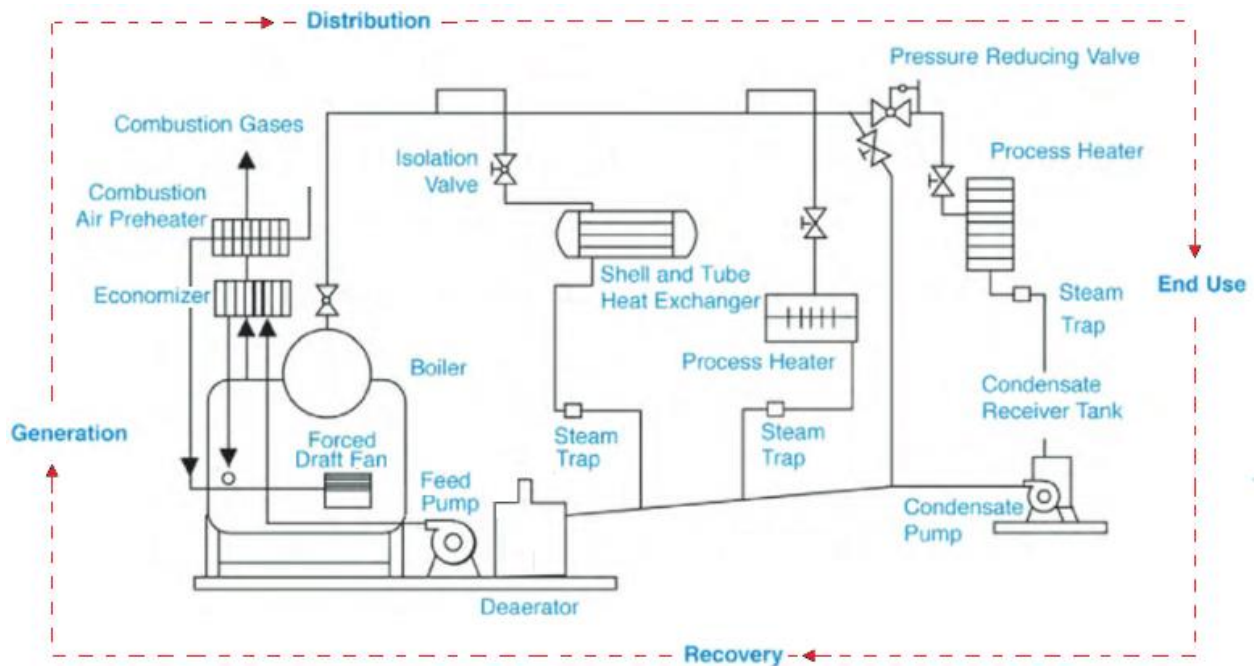

Typical Boiler Schematic

1.1.1. Generation

Where steam is generated in a boiler/generator or heat recovery generator. The components include:

- a. Boilers
- b. Boiler Auxiliaries (Force-Draft, Induced Draft fans, controls, etc.)
- c. Economizers
- d. Air Preheaters
- e. Water Treatment equipment
- f. Deaerator
- g. Feedwater Pumps
- h. Fuel Storage and Handling equipment

1.1.2. Distribution

Where steam is carried from the boiler/generator to the points of end-use. It includes:

- a. Steam Piping
- b. Pressure Reducing Stations (Valves)
- c. Drip legs
- d. Steam Accumulators
- e. Desuperheaters

1.1.3. End-Use

It includes process heating, mechanical drive and moderation of chemical reactions using equipment such as:

- a. Heat Exchangers
- b. Stripping columns
- c. Reaction vessels
- d. Evaporators
- e. Cookers
- f. Dryers
- g. Live Steam Injection Process Heating equipment
- h. Steam Turbines

1.1.4. Condensate Recovery

Where condensate is returned to a collection tank. The components include:

- a. Steam Traps
- b. Condensate Collection Tanks
- c. Condensate Pumps
- d. Condensate Piping

1.2 Steps in Designing Steam Systems

A suggested process to follow when designing a new steam system is summarized as follows:

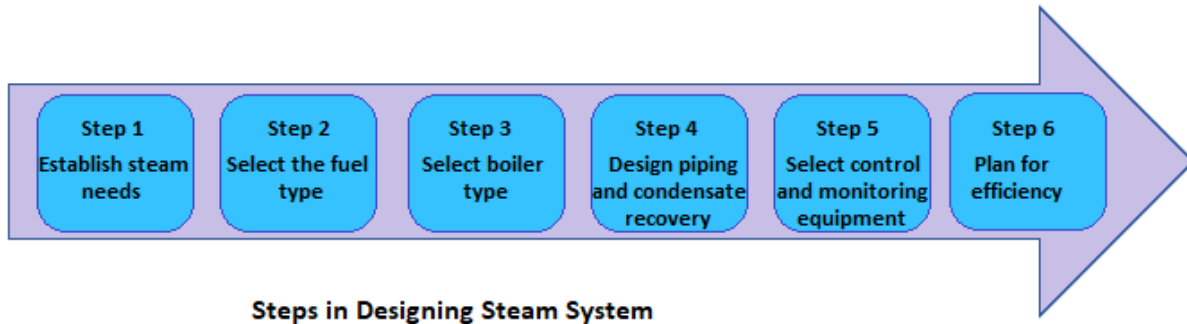

1.2.1. Step 1: Establish Steam Needs

When planning a new steam system, it is important to take stock of exactly what you use steam for and how it is used to help meet your business needs. Compile a list of all end-users of steam, the temperature, pressure, and flow they require, their location, and their options for heat recovery. From this list, you can establish the correct temperature and pressure and the average flow required by your system. It is important to ensure that steam and steam equipment is used safely and appropriately.

As this review is being undertaken, always ask yourself if steam is really needed for the end-use. Steam is an expensive service to generate and maintain. Often, it may be more economical to get the same level of service using heat recovery systems. When thinking about the opportunities for heat recovery, consider all sources of heat around your site. Some examples are:

- a. The condensers of refrigeration systems
- b. Heat rejection heat exchangers for air compressors
- c. Furnace exhausts
- d. Gas turbine exhausts and computer room cooling equipment
- e. Heat rejection heat exchangers.

To assess their potential, measure and observe the temperatures available, the quantity of heat output, and the match between when the heat is available from the source and when you need it for your process.

1.2.2. Step 2: Select the Fuel Type

Selection of the most suitable fuel for your boiler application is an important and sometimes a difficult choice. Options may include natural gas, fuel oil, biomass, coal, and others. General criteria for selecting a fuel include the following:

- a. Boiler type required
- b. The relative cost of fuels
- c. Ability to store the fuel in sufficient quantities for your needs
- d. Ease of handling the fuel
- e. Flue gas cleaning and treatment that may be required when using particular fuels
- f. Stability of the fuel costs
- g. Changes to prices or your circumstances in a carbon-constrained world
- h. Current/future government or company policies that may affect the supply of the chosen fuel
- i. Availability of a continuous supply of the fuel (for example, supply interruptions)
- j. The potential for fouling and the cleaning time required
- k. Maintenance and downtime requirements
- l. Efficiency
- m. Net environmental impact.

Three common fuels are - Coal, Oil, and Natural Gas.

Coal - Coal comes in a variety of grades (or ranks) ranging from lignite, a low-quality, high-moisture fuel, to anthracite, which is very hard coal with low moisture. When burning coal, a considerable amount of carbon dioxide (CO₂) is generated given the extremely high levels of carbon in coal. In addition to the CO₂ emissions, coal-burning creates some other pollutants including nitrous oxide (NO_x), sulfur dioxide (SO₂), sulfur trioxide (SO₃), and particle emissions.

Oil - Oil fuels are mostly a mixture of very heavy hydrocarbons, which have higher levels of hydrogen than those found in coal. At the same time, the oil contains less carbon than coal and therefore requires less combustion air to achieve complete combustion. Therefore, burning oil releases less carbon dioxide than burning coal, but more carbon dioxide than burning natural gas. Most of the pollutants produced when burning coal are also a by-product of burning oil.

The fuel oils can be quite viscous, and so combustion and fuel handling equipment need to be specifically designed to handle it. Fuel oil comes in several grades ranging from light fuel oil, which

is similar to diesel, up to heavy fuel oils, which are the heavy fractions of crude oil left after the distillation process has removed everything else.

Natural Gas - The most used gaseous fuel is natural gas. Natural gases vary in their chemical analysis and, thus, in their heating values. The burning of natural gas produces lesser greenhouse gases and having a low carbon footprint when compared to coal or fuel oil. In equivalent amounts, burning natural gas produces about 30% less carbon dioxide than burning oil and 45% less carbon dioxide than burning coal. In addition to the carbon dioxide emissions, gas-burning creates NOx emissions, while the emissions of sulfur dioxide (SO₂) and Particles are negligible.

The advantage of gaseous-fired boiler is that they are responsive to changing demand and can be started quickly and meet the load variations more efficiently than the equivalent solid or liquid fuel boiler.

1.2.3. Step 3: Select Boiler Type

There are three principal boiler categories: (1) natural draft vs. forced draft, (2) hot water vs. steam, and (3) fire tube vs. water tube.

- a. In a natural draft boiler, the combustion air is drawn in by natural convection and therefore there is little control over the air/fuel ratio.
- b. For forced draft boilers, the quantities of combustion air and air/fuel mixture are controlled by a blower.

Some boilers produce hot water, typically in the 160 to 190°F range, while others produce steam.

- a. Low-pressure boilers produce steam up to 15 psig.
- b. Medium produce steam above 15 psig and up to 150 psig.
- c. High-pressure boilers produce steam above 150 psig

Finally, boilers may be – fire-tube boilers and water-tube boilers. These two designs serve different capacities and market sectors. We will learn more about this in the next chapter.

1.2.4. Step 4: Design your Piping, Fittings, and Condensate Recovery

Once your steam needs have been identified, you can begin to layout your steam distribution and recovery system. This will consist of piping, fittings, valves, steam traps, and possibly flash steam vessels and condensate receivers. The design of your heat recovery opportunities should also be considered at this stage. Thought should be given to sloping your steam pipes to allow for more convenient condensate recovery through natural drainage, rather than requiring dedicated condensate pumps.

Where possible, avoid long pipelines of small diameter. These will use a large portion of the energy contained within the steam just to overcome the flow losses and thermal losses. It may be more cost-effective to install a small dedicated gas or electric steam generator close to the small end-user rather than run piping from the main boiler.

Ensure the pipe diameters are appropriate for the expected loads. If the pipe is too small, the flow losses will be too high, and there will be a risk of condensate being picked up and carried by the high-velocity steam. This can result in excessive wear of the piping and components. If the pipe is too large, then the thermal losses can become high due to the larger pipe surface area.

1.2.5. Step 5: Select Boiler Control and Monitoring Systems

The Boiler Control System (BCS) is a system that controls the entire boiler function including the energy input management system, water level management system, alarm system, pressure controls, trip devices, all instruments, and circuitry. The use of sophisticated monitoring and control systems is essential for continuous monitoring and safety. Details presented in the next chapter.

1.2.6. Step 6: Plan for Efficiency

Integrating the boiler operation with the steam system demands is an important step towards obtaining the most energy-efficient steam system. Often, the operation of the boiler at higher capacity or for longer periods than actually required by plant processes causes a large waste of energy. Scheduling plant processes to create as constant a steam demand as possible, over as short a time as possible is ideal. This will reduce the time the boiler is operating at low capacity, or the number of times that the boiler must be shut down and fired up. The use of sophisticated monitoring and control systems will assist in implementing the most efficient system turndown when demand is low.

1.3 Energy Units and Fuel Properties

The common unit of heat measure in the U.S. is the British thermal unit or Btu. One Btu is the amount of energy needed to raise the temperature of one pound of water one degree Fahrenheit (°F) when water is at about 39 degrees F.

The energy content of a fuel is typically given in Btu per pound of fuel. Fuel oil, for example, has an energy content of roughly 18,500 Btu/lb. For gaseous fuels, the average heating can vary between 900 and 1100 Btu/ cu-ft. depending upon the methane content.

Metric Equivalents

British thermal unit (Btu) is not used universally. The metric units corresponding to Btu's and pounds are kilo-Joules (kJ) and kilograms (kg). The relationships between these measures are:

1 kJ = .948 Btu

1 kg = 2.204 pounds

1 kJ/kg = .429 Btu/pound

1.3.1. Heating Value of Common Fuels

The heating value of a fuel is the measure of energy content. Two heating values are typically assigned to fossil fuels depending upon whether the latent heat of the water formed during combustion is included or excluded.

- a. If the latent heat of water formation is included, the heating value is referred to as the fuel's high heating value or HHV. This is the total fuel energy determined using a calorimeter.
- b. If the latent heat energy is not included, the fuel's heating value is referred to its low heating value or LHV.

Most boilers burn natural gas, fuel oil or liquefied petroleum gas (LPG) as fuel. Approximate heating values of these fuels are shown below.

Heating Values of Common Fossil Fuels

Fuel	Natural Gas	No. 2 Oil (light oil)	No. 4 Oil	No. 6 Oil
Higher Heating Value HHV, Btu/lb	22,450	19,450	18,750	18,350
Lower Heating Value LHV, Btu/lb	20,250	18,250	17,650	17,250

Notes:

- Efficiency is reported both ways (HHV as well as LHV basis). Because these heating values can be significantly different, especially for fuels that have a high hydrogen content, it is important to know which heating value is used.

- Generally, in The United States, the HHV is used whenever efficiency calculations are performed. In Europe, the LHV is often used. Contact your local regulatory agency to determine which value to use. It is important to note that the efficiency value reported with LHV basis would be higher than the value reported with HHV basis.
- HHV is also referred to as the Gross Calorific Value (GCV) and the LHV is also referred to as the Net Calorific Value (NCV).

1.3.2. Ultimate Analysis of Fuel

Two types of fuel analysis – proximate analysis and ultimate analysis is commonly used for its composition.

- Ultimate analysis is at the elemental level, which includes carbon, hydrogen, nitrogen, Sulphur, oxygen, and carbon dioxide. It doesn't include the volatile matter.
- Proximate analysis gives the broader composition of carbon, volatile matter, moisture, and ash.

Ultimate analysis, weight fraction

Fuel	Natural Gas	No. 2 Oil (light oil)	No. 4 Oil	No. 6 Oil
Carbon	0.721	0.865	0.867	0.867
Hydrogen	0.239	0.132	0.115	0.108
Sulphur	Nil	0.003	0.015	0.020
Nitrogen	0.032	Nil	0.003	0.005
Oxygen	0.008	Nil	nil	nil
lb CO₂/10⁶ Btu input	117.8	163.1	169.6	173.2

1.3.3. Boiler Ratings and Efficiency

Boilers can be rated in several ways. The terms Btu/h (Btu per hour), MBtu/h or MB/H (1000 Btu/h) and MMBtu/h indicate the boiler's input rate. Input ratings are usually shown on the boiler's (or burner's) nameplate.

A thousand of international British thermal units per hour (MBtu/h) is a unit of power in the US Customary Units. “M” in MBtu is a Roman numeral, which stands for one thousand (1,000). “MM” in MMBtu stands for one million. “MM” is used instead of the decimal prefix M to avoid confusion with the Roman numeral M, which stands for one thousand.

The terms bhp (boiler horsepower), EDR (equivalent direct radiation), and pounds per hour (of steam) indicate the boiler’s output rate. One boiler horsepower is defined as the amount of energy it takes to convert 34.5 pounds of water to steam in one hour at 212 degrees Fahrenheit. A boiler HP equals 33,472 Btu/hour.

1.3.4. Energy Units for Natural Gas

The most common unit for measuring natural gas is the “Therm”, which is equivalent to 100,000 British thermal units. One therm worth of natural gas contains 96.7 cubic feet, which people roughly estimate as 100 cubic feet. Since the energy in natural gas is equivalent to the gas’s volume, you can freely convert between BTUs per hour and cubic feet per minute (CFM).

1.3.5. Energy Units for Fuel Oil

- a. 1 Gal of #2 Fuel Oil 138,700 Btu’s
- b. 1 Gal of #4 Fuel Oil 145,000 Btu’s
- c. 1 Gal of #6 Fuel Oil 149,700 Btu’s

1.3.6. Cost of Steam

The steam generating cost and the amount of input fuel depends on the fuel energy content and on the overall energy efficiency. The formula below provides a good first approximation for the cost of generating steam and serves as a tracking device to allow for boiler performance monitoring.

Energy cost (\$ per million Btu) = Cost per unit of fuel ÷ [Fuel energy content (in millions Btu per unit) × system efficiency (in decimal).]

To use the formula, remember to use a decimal for the heating efficiency. You must first convert the Btu content of the fuel per unit to millions of Btu by dividing the fuel’s Btu content per unit by 1,000,000.

You can contact the utility or fuel supplier in your area for the unit price of the fuel and the cost to deliver it to your premises.

You also need to know the efficiency of the equipment. The Table below lists the typical energy content and boiler combustion efficiency for several common fuels.

Energy Content and Combustion Efficiency of Fuels

Fuel Type, sales unit	Energy Content, Btu/sales unit	Combustion Efficiency, %
Natural Gas, MMBtu	1,000,000	85.7
Natural Gas, Thousand cubic feet	1,030,000	85.7
Fuel Oil #2, Gallons	138,700	88.7
Fuel Oil #6, Gallons	149,700	89.6

Note – Combustion efficiency is based on boilers equipped with feedwater economizers or air preheaters and 3% in the flue gas.

1.3.7. Benchmarking the fuel cost

Benchmarking the fuel cost of steam generation, in dollars per 1,000 pounds (\$/1,000 lb) of steam, is an effective way to assess the efficiency of your steam system.

The Table below shows the energy (heat input) required to produce 1 pound of saturated steam at different operating pressures and varying feedwater temperatures.

Energy Required in Btu’s to Produce One Pound of Saturated Steam

Operating Pressure, psig	Feedwater Temperature, F				
	50	100	150	200	250
150	1178	1128	1078	1028	977
450	1187	1137	1087	1037	986
600	1184	1134	1084	1034	984

Note - Calculated for steam tables based on the difference between the enthalpies of saturated steam and feedwater

The energy efficiency is a major cost drive for boilers as the fuel cost accounts for more than 90% of the boiler overall costs on a life-cycle basis. Improving the energy performance of steam systems require continuous metering of fuel and steam parameters, assessing/auditing the entire system, identifying opportunities, and implementing the most feasible and cost-effective solution that yields lower paybacks. We will focus on the energy efficiency measures later in this course.

2.0. CHAPTER - 2: SYSTEM EQUIPMENT AND COMPONENTS

Steam is exported from the boiler solely by virtue of a pressure difference between the boiler and point of use. The rate of steam flow is determined by the process calling for the steam. The quality of the steam, e.g., pressure, wetness and cleanliness are affected by the rate of demand from the process, rate of change of demand, design and operating characteristics of the boiler supplying the steam and the condition of the distribution and condensate return systems.

The water supplied to the boiler that is converted into steam is called feed water. Treated cold feed water is fed to the boiler, where it is heated to form steam. Chemical treatment of the feed water is required to remove impurities. The impurities would otherwise collect on the boiler walls. Even though the feed water has been treated, some impurities remain and can build up in the boiler water. As a result, water is periodically drained from the bottom of the boiler, a process known as blowdown. For higher boiler efficiencies, the feed water is preheated by an economizer, using the waste heat in the flue gas.

The generated steam travels along the pipes of the distribution system to get to the process where its heat will be used. Sometimes steam is passed through a pressure reduction valve if the process requires lower pressure steam. As steam is used to heat processes, and even as it travels through the distribution system to get there, the steam cools and some of it condenses. This condensate is removed by a steam trap, which allows condensate to pass through, but blocks the passage of steam. The condensate can be recirculated to the boiler, thus recovering some heat reducing the need for fresh treated feed water.

The figure below shows the typical flow of steam distribution, utilization, and condensate recovery.

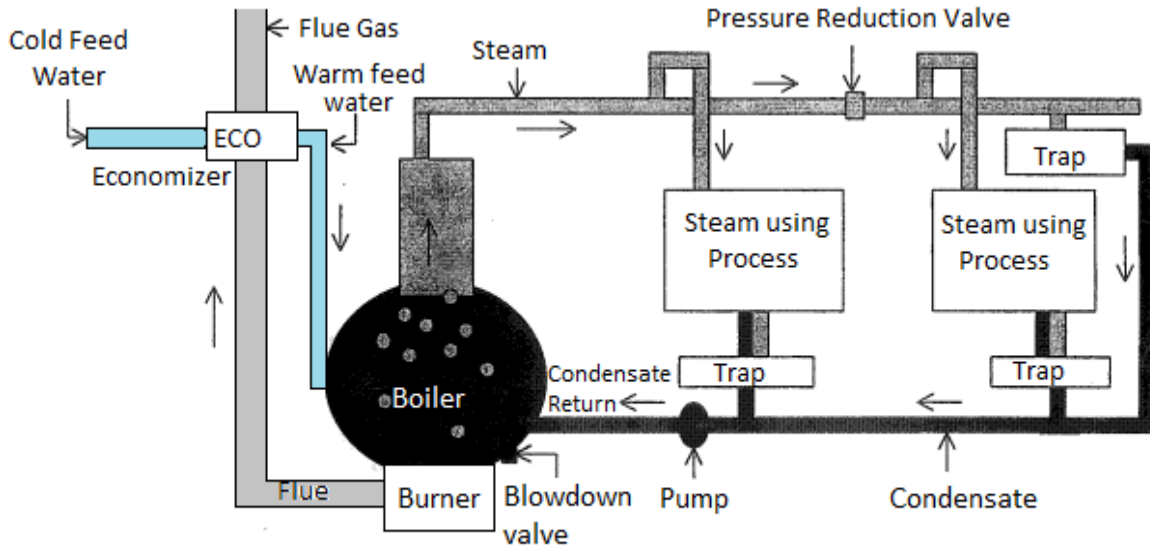

Steam Production and Distribution Schematic

2.1 Steam Generation Equipment

A steam system uses boilers to generate steam.

The boiler serves as a furnace or combustion chamber, where air is mixed with the fuel in a controlled process to release large quantities of combustion gases and heat. The heat is absorbed by water to produce steam. The combustion gases are released to the atmosphere via the stack of exhaust section of the boiler.

Steam boilers are broadly classified as “fire-tube” or “water-tube” boilers.

2.1.1. Fire-Tube Boilers

In fire tube boilers, the boiler shell contains the water & steam, and hot combustion gases pass through the tubes to heat the water.

Fire-tube boilers are popular for smaller applications requiring saturated steam at less than 150 psig because of their low first cost and durability. The large volume of water/steam serves as a thermal mass which enhances steady operation. However, because the steam is generated on the shell side, the shell itself is a pressure vessel, making it difficult to generate steam at high pressures. In addition, the large surface area causes relatively large heat loss, which varies from about 0.5% of input energy at the full fire to a much higher fraction at low loads.

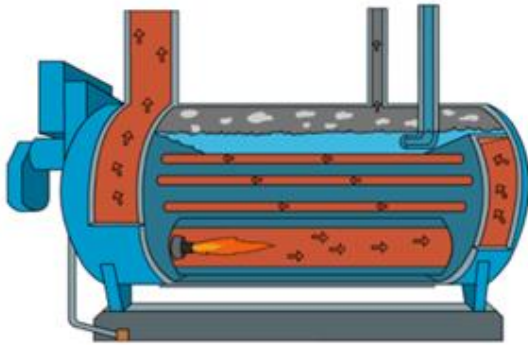

Fire-Tube Boiler

Fire tube boilers are often characterized by their number of passes, referring to the number of times the combustion (or flue) gases flow the length of the pressure vessel as they transfer heat to the water. Each pass sends the flue gases through the tubes in the opposite direction. To make another pass, the gases turn 180 degrees and pass back through the shell.

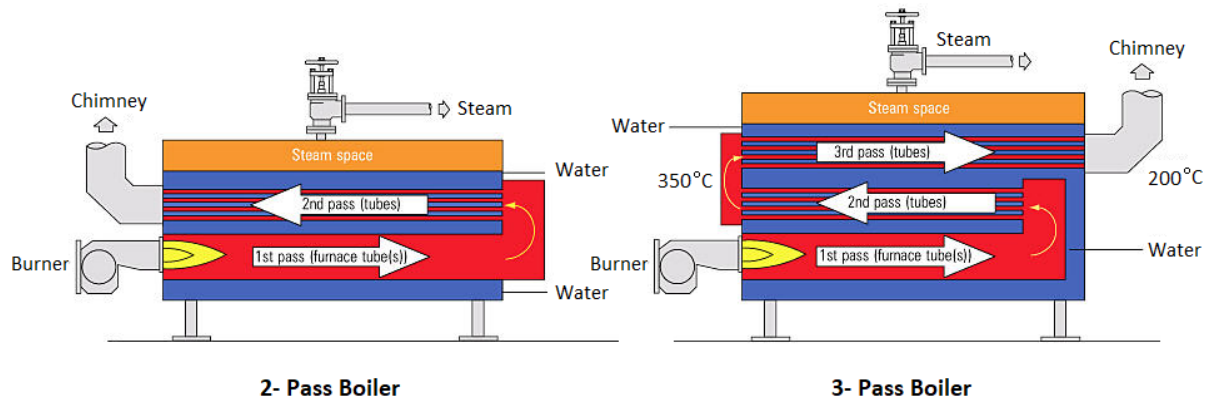

A boiler with two passes provides two opportunities for the hot gasses to exchange heat to the water in the boiler. A 3-pass unit provides three opportunities for heat transfer and a 4-pass unit will provide four opportunities. The stack temperature of a 4-pass boiler will be lower than the stack temperature of a similar size 2- or 3-pass boiler operating under similar conditions. The 4-pass design yields higher heat-transfer coefficients and will have higher efficiencies and lower fuel costs. The higher number of passes, however, also increases the amount of material it contains and therefore affects the first cost.

Caution: The number of boiler-passes simply represents the number of times the hot combustion gas travels through the boiler. While a boiler with more passes would be more efficient, this may

not be true. There have been advances in heat transfer tube design which can nearly double the heat transfer rate of the new tube compared to a standard smooth tube. Do not evaluate boiler efficiency simply by the number of passes.

The advantages of the fire-tube boiler design include the following:

- a. Relatively inexpensive
- b. Easy to clean
- c. Less rigid in their water treatment requirements
- d. Compact in size, with simple construction
- e. Easy tube replacement
- f. Well-suited for space heating and industrial process applications

The disadvantages of the fire-tube boiler design include the following:

- a. Not suitable for high-pressure applications of 250 psig and above
- b. Limited in their capacity for steam generation
- c. Excessively heavy per pound of steam generated
- d. Relatively slow to raise steam pressure because of the large volume of water
- e. Unable to respond quickly to load changes, again, due to the large water volume

2.1.2. Water-Tube Boilers

In water-tube boilers, the water/steam passes through tubes, and the hot combustion gases pass through the shell of the boiler. These boilers have separate steam and water drums that are connected by tubes through which the water circulates. The basic principle of operation is that the water is injected into a water drum and then flows through the tubes and into the steam drum located at a higher-level boiling to form steam.

Water-tube boilers are mostly used where high outputs and steam pressures are required (exceeding 300 psig). This is because, for high-pressure applications, it is easier to construct small diameter tubes to handle the high pressures of the steam than an entire boiler shell. In addition, the tubes can be configured to pass through high-temperature combustion gases before exiting the boiler to create super-heated steam. Thus, most high-pressure applications like power generation use water tube boilers.

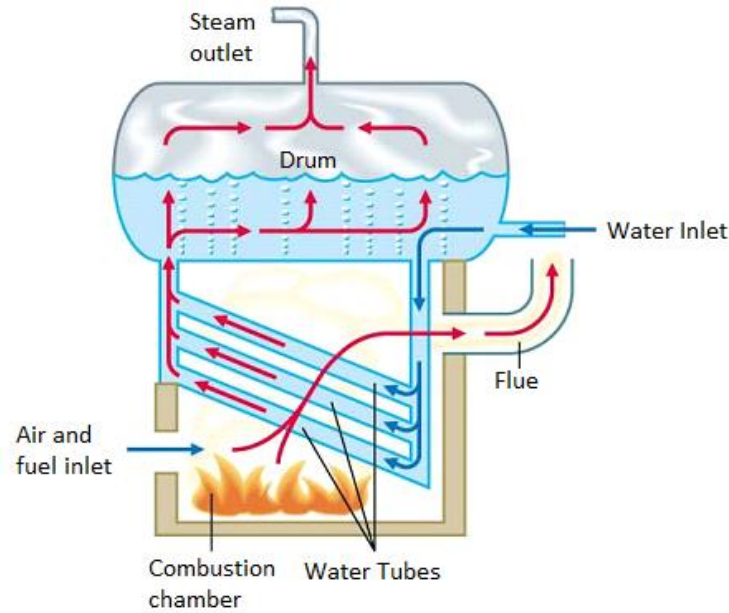

Water Tube Boiler Schematic

The advantages of the water-tube boiler design include the following:

- a. Available in sizes far greater than a fire-tube design, up to several million pounds per hour of steam.
- b. Able to handle higher pressures, up to 5,000 psig.
- c. Can handle rapid load swings and capable of recovering faster from load changes than fire-tube boilers.
- d. These have a high rate of water circulation and heat transfer compared to their fire-tube equivalents.
- e. Water-tube boilers can generate saturated or superheated steam, which is useful for applications such as steam turbine power generation. In addition, these boilers are commonly used in process industries, including chemicals, refining, and pulp and paper manufacturing.

The disadvantages of the water-tube design include the following:

- a. High initial capital cost.
- b. A design that makes cleaning more difficult.
- c. Require more controls and are much more demanding in their operating requirements, particularly water treatment.
- d. No commonality between tubes.
- e. Possible issues from their physical size.

2.1.3. Steam Generators

Steam generators are like water-tube boilers, except they are made from lightweight materials. In many jurisdictions, the lack of a dedicated pressure vessel enables steam generators to be used without a boiler operator. The lightweight materials and absence of a large holding tank allow steam generators to come up to pressure quickly in a manner of minutes. This enables steam generators to be turned on and off as needed, reducing standby losses. Installing the water-tubes in a counter-flow configuration to the path of the combustion gases increases thermal efficiency.

2.1.4. Steam Separating Equipment

The water heated in a steam boiler will exit the boiler as a two-phase mixture of steam and liquid water. The mixture is separated in a vessel with a volume that will allow the liquid water to settle out. The liquid water can then be returned to the boiler for further heating while the steam enters the steam distribution system. In some cases, the steam will be superheated by passing it back through the boiler using a heat exchanger dedicated to superheating.

2.1.5. Blowdown System

As water evaporates in the boiler steam drum, solids present in the feedwater are left behind. The suspended solids form sludge or sediments in the boiler, which degrades heat transfer. If not removed, these can accelerate corrosion and decrease the performance of the boiler and steam system. Periodic blowdown, where steam is vented into a vessel open to the atmosphere, will remove a portion of the contaminated water from the system so that it may be replaced with fresh water. The optimum blowdown rate is determined by various factors including the boiler type, operating pressure, water treatment, and quality of makeup water. Blowdown rates typically range from 4% to 8% of boiler feedwater flow rate but can be as high as 10% when makeup water has a high solids content.

Blowdown may be a manual operation, or automatically triggered by a timer, or in the more efficient systems by water quality monitoring equipment detecting concentrations of contaminants reaching a maximum allowable level.

2.1.6. Deaerator Tank

Makeup water and condensate contain dissolved oxygen, carbon dioxide, and ammonia. These dissolved gases reduce the conductivity of the steam and hence its ability to transfer heat. More importantly, oxygen is highly corrosive and leads to pitting and possible system failure.

Economizers are particularly susceptible to oxygen pitting. For these reasons, oxygen is typically removed from steam systems by a deaerator.

A deaerator works by spraying makeup water into a steam environment and heating the makeup water to within about 5°F of saturation temperature. At this temperature, the solubility of oxygen is low, and the makeup water contains very little oxygen. Oxygen and flash vapors are vented to the atmosphere. To function effectively, the pressure of the deaerator can only be a few psi above ambient pressure, or else the oxygen will be forced back into the water.

2.1.7. Feedwater Tank

Condensate and make-up water is collected in the feedwater tank. Automatic dosing of corrosion inhibitor chemicals may also occur in the feedwater tank.

2.1.8. Feedwater Pump

Water from the feedwater tank is pumped to the boiler to start the process again. Flow from the boiler feed pump is usually controlled by a modulating valve that is connected to a water-level sensor in the boiler. As the water level drops due to steam production, more water is supplied with the boiler feed pump.

2.2 Steam Distribution Components

Steam is generally distributed to the plant through a large main header pipe which connects to smaller branch pipes. Initially there will be one or more main pipes, or 'steam mains', which carry steam from the boiler in the general direction of the steam using plant. Smaller branch pipes can then carry the steam to the individual pieces of equipment.

The pipes are sized to minimize the pressure losses, heat losses, and keep the steam velocities low enough that it will not pick up condensate. All pipes in a network have a gradient to ensure condensates can be efficiently drained from the pipe system.

It is a common practice to design piping systems in the following ranges:

- a. Superheated: 9000 - 14000 ft/min
- b. Saturated: 4800 – 7200 ft/min
- c. Wet or Exhaust: 3600 – 6000 ft/min
- d. Pressure drop, as a rule, should not exceed 1 psig/100 ft. length.

Lower velocities reduce pressure loss, pipe erosion, water hammer, and noise as well as providing more efficient condensate drainage.

2.2.1. Steam Vents

As steam condenses on a cold surface, a thin film of condensate is produced and any air entrained with the steam is released. The air in a steam system causes two major problems. First, even a thin layer of air on a heat transfer surface dramatically reduces the heat transfer across the surface. For example, a layer of air 0.04 inches thick adds the same thermal resistance as a layer of water 1 inch thick or a layer of iron 4.3 feet thick. Second, when air is absorbed into condensate, carbonic acid is produced. This acid can attack piping and heat exchange surfaces. To reduce air in the piping system, thermostatic air vents should be installed at high points, the end of steam mains, and on all heat exchange equipment.

2.2.2. Safety Valves

These are valves that discharge to the atmosphere if they encounter a pressure higher than their set pressure. They are very important as they prevent overpressure either on vessels such as steam boilers, pressure vessels, or downstream of the pressure reducing valves.

2.2.3. Isolation valves

The isolation valves simply permit or deny steam flow. They can be either manual or automatic in operation and are used extensively in steam plants. During the normal operation, they should always be either fully open or fully closed. Isolation valves are vital when the plant is being isolated for work on the steam.

2.2.4. Control Valves

These are valves that regulate the flow of steam. They may be manual or automatic in operation, although in industrial settings the vast majority are automatic.

2.2.5. Pressure Reducing Valves (PRV)

Pressure reducing valves are used to reduce the pressure to that required close to the point of consumption. Pressure gauges and safety valves should always be fitted downstream of them. The complete set of valves and other equipment associated with a PRV are frequently referred to as a pressure-reducing set or station.

2.2.6. Non-return Valves/Check Valves

Non-return/check valves ensure that the steam and condensate should only flow in one direction. They are important pieces of equipment as they can prevent unwanted or potentially dangerous occurrences.

2.2.7. Strainers

Steam is aggressive and erodes steam pipes. Strainers are used to filter out any debris that may be contained in the system. They are frequently located in front of control and reducing valves. They should always be included in trap sets.

2.2.8. Separators

Separators can be present throughout a steam network where high-quality steam delivered to an end-user is important. The wet steam enters a separator and slows down due to the diameter of the separator vessel being larger than the steam pipe. The condensed water can drop out of the steam and be transferred to the condensate return network while the now dry steam can be passed through the process. Separators may also be fitted with equipment to remove air.

2.3 Steam Utilization at End-user

The end-user will tend to be a heat exchanger, but some processes may use the direct injection of steam to heat a process or be used for providing mechanical equipment such as turbines. Where the steam is not used directly in the process, the condensed steam can be collected and returned to the boiler for reuse.

2.3.1. Condensate Return Network

Condensate is produced and carried along with the steam as steam condenses on the inside surface of the pipes. Although it is important to remove this condensate from the steam space, it is a valuable commodity and should not be allowed to run to waste. Returning all condensate to the boiler feed tank closes the basic steam loop and should be practiced wherever practical.

In open condensate return systems, the condensate return tank is open to the environment, and condensate is pumped back to the boiler. The enthalpy of condensate at atmospheric pressure is substantially less than the enthalpy of condensate at the operating pressure of a steam system. Thus, the energy released as the pressure of condensate falls to atmospheric pressure, vaporizes some of the condensate into “flash” steam, which is discharged to the atmosphere.

In closed condensate return systems, steam pressure forces the condensate all the way back to the deaerator tank. Thus, in closed systems, flash steam is created as the pressure of condensate falls to the pressure of the deaerator tank and is discharged to the atmosphere from the deaerator rather than the condensate return tank.

2.3.2. Steam Traps

A steam trap is a device that removes condensate from a steam system. A typical steam system will have many steam traps – they are placed at every 100 to 160 ft intervals in a straight pipe, and at the bottom of risers or drops.

The three most common types of steam traps are:

- a. Thermostatic (operated by changes in fluid temperature)
- b. Thermodynamic (operated by changes in fluid dynamics)
- c. Mechanical (operated by changes in fluid density).

2.3.3. Steam Accumulator

In some installations, a steam accumulator may be present. This is a method of storing steam for use during high-demand periods. Steam from the boiler is injected into the accumulator, which contains water under pressure at its saturation temperature. When the demand for steam exceeds the boiler's capability, the discharge valve opens and flash steam is created, as the discharge pressure is below that of the accumulator. In this way, the accumulator provides for the excess demand that the boiler cannot handle, allowing for a smaller boiler to be used but still providing for peak capacity. Also, when demand is low, the boiler will charge the accumulator with steam, providing extra demand on the boiler and so flattening its load profile. In the case of fire-tube boilers, the volume of water contained within the boiler itself can achieve the same function as having an accumulator.

2.4 Controls and Instrumentation

Control systems for boilers range from very simple to sophisticated computer control that can monitor and control the oxygen content in the flue gas, fuel feed rates, temperatures, and pressures, and provide a historic record of the boiler performance. Figure below shows typical instrumentation used in the boiler.

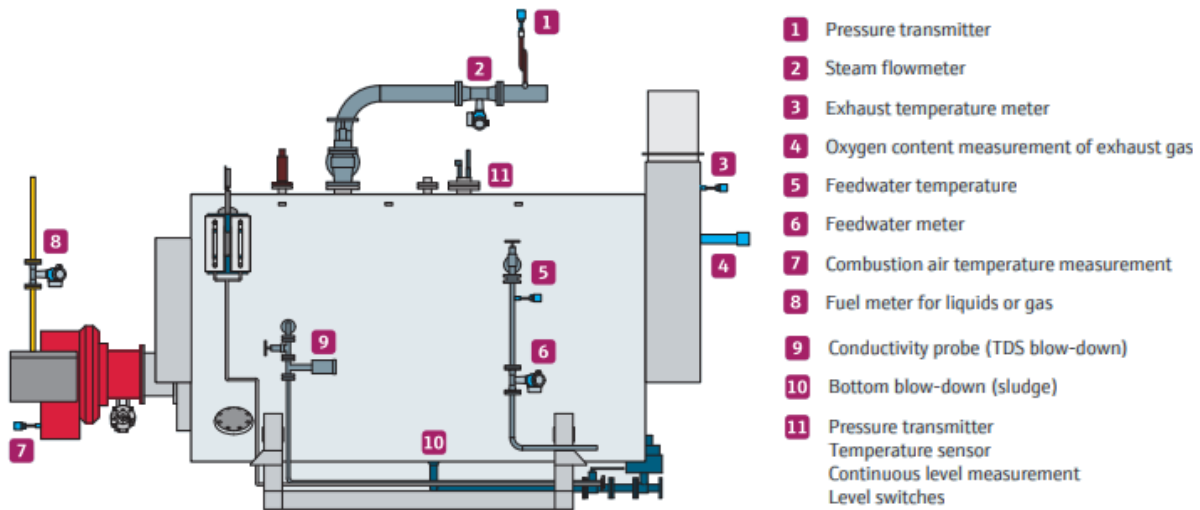

Basic Boiler Instrumentation

2.4.1. Pressure Transmitter

A pressure transmitter is fitted directly to the boiler and linked to the burner for control and safety purposes. These are, however, normally supplied and fitted by either the burner or boiler manufacturer.

2.4.2. Steam Flowmeter

A steam flowmeter is used in conjunction with the level controls and a feedwater meter in a three-element anticipatory control loop to optimize the boiler operation. This can reduce the pressure fluctuations and reduce the negative effects of priming.

2.4.3. Exhaust Temperature Transmitter

A measurement of the exhaust temperature is also required for the calculation of indirect efficiencies. A boiler's exhaust temperature is a function of the boiler design, firing rate, and fluid temperature. If the exhaust temperature rises independently of these factors, it indicates that the heat transfer inside the boiler has deteriorated.

2.4.4. The Oxygen Content of the Exhaust Gases

This equipment is used to control the burner trim and can also be used for indirect efficiency calculations. The oxygen content is required for the calculation of indirect efficiencies.

2.4.5. Feedwater Temperature Transmitter

The temperature of the feedwater is important. Too low a temperature may result in thermal shock and the formation of cracks in the pressure vessel.

This indicates an excessive oxygen content which in turn causes corrosion and a causal factor in catastrophic failures.

2.4.6. Feedwater Metering with Temperature Compensation

Feedwater meters are used to determine blowdown, warn of a change in the conductivity, proportional dosing of chemicals, and direct efficiencies when combined with a steam flowmeter.

2.4.7. Steam Metering

Steam metering is expensive but gives valuable information for managing a steam system. Most steam meters work by measuring the pressure difference across a pressure reduction valve and comparing the output to calibrated values. High-quality steam metering devices for a 4-inch steam pipe costs about \$4,000.

2.4.8. Combustion Control System

Combustion control systems are used for fuel supply regulation, control of the air-fuel ratio over the entire load range, and flame failure detection. Should a flame failure occur on start-up or during normal operation, the flame monitoring device will shut down and lock out the burner thereby preventing a potentially dangerous accumulation of combustible gases in the furnace or boiler gas passages.

2.4.9. Fuel Meters

Fuel meters are used in the calculation of total fuel consumptions and costs, as well as for determination of direct and indirect efficiencies.

2.4.10. Total Dissolved Solids (TDS)

The feed water to the boiler contains both impurities and chemicals. However, the steam exported is relatively pure water, consequently, the impurities become concentrated inside the boiler. If the concentration of dissolved solids is too high, foaming will occur. Excessive foaming can cause carryover of solids into the distribution system, or in severe cases result in a failure of certain type of level controls. The TDS of the boiler is controlled by measuring it and blowing down the boiler if it is too high. This reduces the TDS inside the boiler to an allowable level. TDS blowdown

systems are frequently sold as packages with all the necessary controllers, valve and the sensor contained within.

2.4.11. Steam Pressure Control

This system regulates the combustion control system and thereby the steam output to maintain constant pressure in the steam header.

2.4.12. Water Level Control

It is crucial to maintain a sufficient quantity of water within a boiler to prevent the heated surfaces from becoming exposed to steam when the burner is firing (a dangerous low-water condition). A dangerous low-water condition places the boiler pressure vessel at risk of catastrophic failure. The level controls comprise of a control unit for the pump and two independent level limiters. The level controller regulates the feedwater pump. In the event of some failure of the controller, the two limiters are independently connected to the burner to force its shutdown and lock-out, requiring a manual reset. These controls are required to be fail-safe, high integrity, and self-monitoring. An additional high-water alarm and cut-out may also be provided.

3.0. CHAPTER - 3: FUNDAMENTALS OF COMBUSTION

Combustion is a process in which fuel elements such as carbon and hydrogen react with oxygen to give heat and exhausted air.

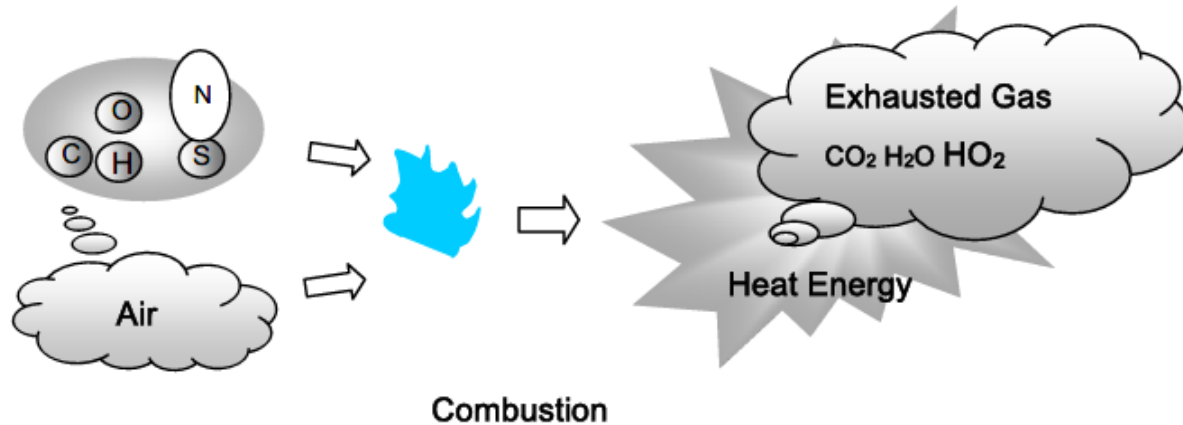

When gas, oil, or another fuel is burned, several factors must be considered, if the burning process is to be safe, efficient, and not impact the environment. The burning process must adhere to three important rules:

- a. Provide enough air so that combustion is complete, and undesirable amounts of carbon monoxide or other pollutants are not generated.
- b. Avoid excess air in the fuel-air mixture which would result in low efficiency.
- c. Completely mix the air with fuel before introducing the mixture into the firebox.

3.1 Fundamentals of Good Combustion

Good combustion is the ability to mix air and fuel, with as little excess air as possible, at a high enough temperature to sustain the process and completely burn the fuel (complete carbon conversion) with minimum environmental emissions. Good combustion also includes the ability to generate maximum usable energy consistent with process needs, safety, and economics.

Nearly complete combustion can be achieved when:

1. The fuel and oxygen have enough time to react.
2. The fuel and oxygen are within the proper temperature range.
3. The fuel and oxygen must be appropriately mixed.

If any component is missing or diminished, the reaction will not proceed to completion and combustibles will exit the combustion zone. This is often described as “the three T’s of combustion: Time, Temperature and Turbulence”.

When fuel and air are well mixed and all the fuel is burned, the flame temperature will be very high, and the combustion time will be shorter. When the fuel and air is not well mixed, complete combustion may not occur, the flame temperature will be lower, and the fuel will take longer to burn.

Given complete mixing, a precise or stoichiometric amount of air is required to completely react with a given quantity of fuel. In practice, combustion conditions are never ideal, and additional or “excess” air must be supplied to completely burn the fuel.

3.1.1. Perfect Combustion

Perfect combustion (or stoichiometric combustion) is achieved when all the fuel is burnt, using only the theoretically ideal amount of air i.e. without an excess of combustion air. Unfortunately, it is impossible to achieve a perfect combination of air and fuel in a burner and perfect combustion can rarely be achieved in practice. This is because the mixing of the fuel and air (turbulence) is not perfect and some of the oxygen does not come in contact with the fuel while in the flame zone where temperatures are sufficient for combustion.

Therefore, we strive for the perfect balance – Stoichiometric Combustion.

3.1.2. Stoichiometric Air

The minimum amount of air required for complete combustion is called the “stoichiometric” air.

When fuel burns in the presence of oxygen, it is converted to carbon dioxide, water, and heat. If we assume methane (CH₄, the primary constituent of natural gas) is the fuel, then the combustion reaction could be represented as follows:

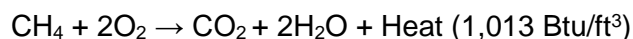

Air consists of about 1 mole of oxygen to 3.76 moles of nitrogen. In this case, the reaction for complete combustion becomes:

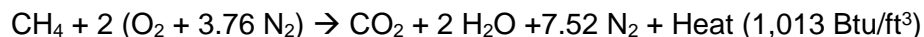

It is possible to predict the amount of air needed to completely burn one pound of fuel and this is called the theoretical air requirement or the air to fuel ratio (AF). AF can be calculated using the molecular masses of the air and fuel at stoichiometric conditions. For combustion of natural gas in air, AF is about:

$$AF = \frac{m_{AIR}}{m_{Gas}} = \frac{2 \times [(2 \times 16) + (3.76 \times 2 \times 14)]}{[12 + (4 \times 1)]} = 17.2 \text{ lb air/lb gas}$$

The equations demonstrate that 1 lb of methane (CH₄) theoretically requires 17.2 lbs. of air to completely burn, assuming perfect mixing and combustion. Because gas flow rates are usually measured in cubic feet and fans are volumetric devices used to deliver the combustion air, conversions are made from pounds to cubic feet.

Density of air @70F = 0.074 lb/ft³

Density of methane gas @ 70°F = 0.0416 lb/ft³

$$AF = \frac{17.2 \text{ lb}/0.074\text{lb}/\text{cu. ft}}{1 \text{ lb}/0.0416\text{lb}/\text{cu. ft}} = 9.6 \text{ cu ft air}/\text{cu ft gas}$$

As a "rule of thumb," 1 ft³ of natural gas theoretically requires 9.6 ft³ of air for complete combustion at 70°F and 14.7 psi under perfect conditions.

ASHRAE 1985 Fundamentals Handbook (pg. 15.8) lists these values as shown in the table below.

Fuel	Stoichiometric Air/Fuel Ratio	Heat of Combustion
Methane (CH ₄)	9.6 air ft ³ /fuel ft ³	1013 Btu/ft ³
Propane (C ₃ H ₈)	23.82 air ft ³ /fuel ft ³	2590 Btu/ft ³
Natural Gas	9.4 – 11.0 air ft ³ /fuel ft ³	950 - 1150 Btu/ft ³
No. 2 Oil	180 -195 air ft ³ /fuel lb	18500 -19800 Btu/lb
No. 6 Oil	170 -185 air ft ³ /fuel lb	17500 -19000 Btu/lb
Bituminous Coal	120 -140 air ft ³ /fuel lb	12000 -14000 Btu/lb

In theory, a stoichiometric combustion is never quite achieved. Some additional or “excess” air must be supplied to completely burn the fuel. The stoichiometric combustion only gives us a target in which we might compare our combustion conditions against. For example, if we supply too little air, the burner will run “rich”. This means that not all the fuel is burned and results in unburned combustibles, soot, and carbon monoxide in flue gasses. In addition, high concentrations of combustibles create an environmental concern and a potentially explosive condition. On the other side, too much air incurs more heat loss due to unnecessary flue gas flow -- thus lowering the overall efficiency.

If you notice in the table above, the Stoichiometric Air/Fuel Ratio varies with the type of fuel. As for a general rule of thumb...how about 0.9 cubic feet of air for 100 Btu of fuel.

3.1.3. Excess Air

Excess air is defined as “the amount of air needed by a burner which is more than the amount required for perfect or stoichiometric combustion”. Excess air is expressed as a percentage of 100% theoretical air, and is given by equation:

$$\text{Excess Air \%} = \frac{(\text{Air supplied} - \text{Theoretical air})}{\text{Theoretical air}} \times 100$$

Greater amounts of excess air mean more heat losses and reduced efficiency. The graph below shows that the efficiency decreases with increasing excess air and increasing exhaust air temperature.

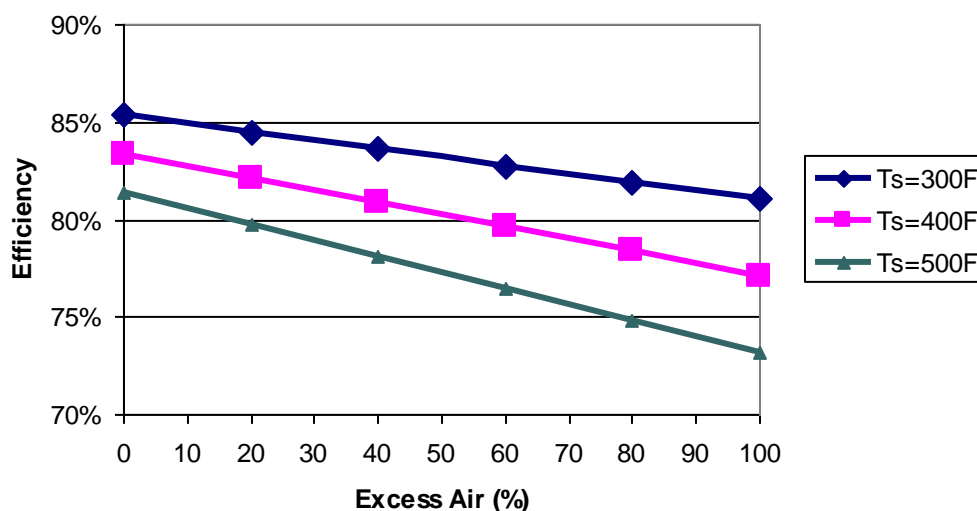

The correct amount of excess air is determined from analyzing flue gas oxygen or carbon dioxide concentrations. As shown in the figure below, as the air is increased the combustion is improved. But the high percent of excess air increases the stack losses.

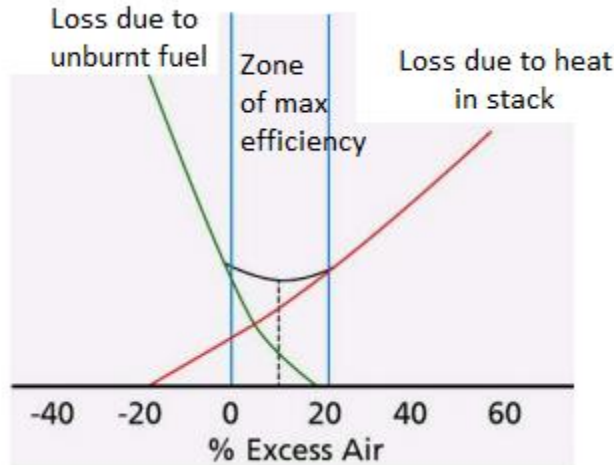







Minimizing excess air, consistent with complete combustion, minimizes the heat loss up the stack and improves combustion efficiency. On well-designed natural gas-fired systems, an excess air level of less than 10% is attainable.

3.2 Combustion Monitoring

The simplest and approximate way to observe combustion is to notice the flame for the color, shape, and stability or simply visualizing the color of smoke.

- a. If the flame is short, contain orange, and has light grey smoke, there is optimum air.
- b. If the flame is noisy, spiky, long unstable, and contains white smoke, there is too much excess air in relation to the amount of gas.
- c. If the flame is dark red, wavy, and contains dark grey smoke, there is too much gas and not enough oxygen.

Quantity of air	Frame appearance	Smoke
Optimum air	Orange and short stable flame 	Light Grey 
Excess air	White and long unstable flame	White or no colour

		
Less air	Dark red flame 	Dark grey 

3.3 Combustion Flue Gas Analyzers

Eyeballing the flame for color, shape, and stability or simply visualizing the color of smoke is not enough for precision adjustments. Combustion can be monitored by flue gas analyzers. For large boilers, over 1,000,000 Btu/h, the analysis is typically continuous. For small boilers, portable flue gas monitors are used to maintain optimum flame temperature, and monitor CO, oxygen, and smoke.

Since the oxygen in the flue gas is directly related to the amount of excess air supplied, an oxygen flue gas analyzer is the best way to effectively measure and control the amount of excess air in the flue gas and the associated heat loss. High percentage of carbon monoxide (CO) presence in the flue gas of a boiler is an indicator of incomplete combustion and low excess air. Using a combination of CO and oxygen readings, it is possible to optimize the fuel/air mixture for high flame temperature (and thus the best energy efficiency) and low emissions.

Oxygen (O₂) percentage measurement by volume basis can be done by using zirconium oxide probes. The modern combustion analyzers using the latest sensor technology can simultaneously measure carbon monoxide (CO), oxygen (O₂), carbon dioxide (CO₂), nitrogen oxides (NO_x), sulfur oxides (SO₂) and even flue gas temperatures. The following symptoms are used for analysis.

Carbon Dioxide (CO ₂)	Indicates complete combustion
Carbon Monoxide (CO)	Indicates incomplete combustion/low excess air
Oxygen (O ₂)	Indicates the presence of excess air

Oxides of Nitrogen (NOx)	A product of high-temperature combustion
Combustibles	Material that burns when exposed to oxygen and heat

The ideal amount of excess air used for different fuels is listed below:

Type of Fuel	Oxygen (%)	Carbon dioxide (%)	Carbon monoxide (ppm)	Excess air (%)
Fuel Oil	3 - 4	12-14	<200	10 -20 %
Natural Gas	1 - 3	9-10	<200	5 -10 %
Solid fuel (Coal)	12 -13	12-13	<200	20 -50 %

As you can observe from the table above that the solid fuel has the higher excess air requirements compared to gas and liquid fuels.

3.4 Understanding Combustion Efficiency

Combustion efficiency is a measure of how effectively the heat content of a fuel is transferred into usable heat. It indicates the ability of the burner to use fuel completely without generating carbon monoxide or without unburnt carbon.

Combustion efficiency is determined by subtracting the heat content of the exhaust gases, expressed as a percentage of the fuel’s heating value, from the total fuel-heat potential or 100%, as shown in the formula below.

$$\text{Combustion Efficiency (\%)} = 100\% - \left(\frac{\text{Stack heat losses/lb fuel}}{\text{Fuel heating value/lb fuel}} \times 100 \right)$$

Combustion efficiency calculations are based on three factors:

- a. The chemistry of the fuel and its heating value.
- b. Stack or flue gas heat losses which in turn is dependent on:
 - The temperature of the flue gasses leaving the stack.
 - The CO₂ or O₂ concentration by volume after the combustion process.

The relationship of combustion efficiency with excess air and exhaust air temperature is shown in the table below for Natural Gas.

Combustion Efficiency for Natural Gas

Excess Air %	Flue gas temperature less combustion air temp, °F				
	200	300	400	500	600
9.5	85.4	83.1	80.8	78.4	76.0
15.0	85.2	82.8	80.4	77.9	75.4
28.1	84.7	82.1	79.5	76.7	74.0
44.9	84.1	81.2	78.2	75.2	72.1
81.6	82.8	79.3	75.6	71.9	68.2

Flue gas heat loss increases with both increasing excess air and temperatures as shown in Figure below:

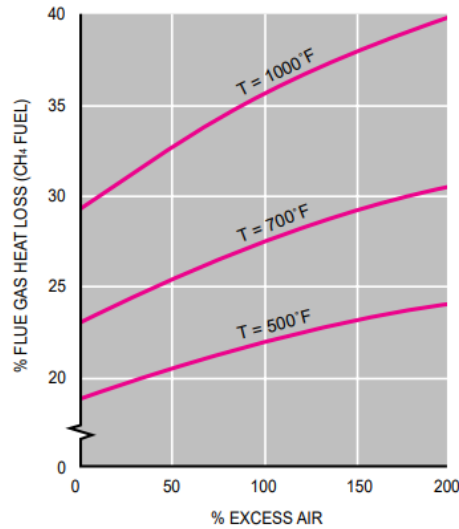

The more air is used to burn the fuel, the more heat is wasted in heating air. Air slightly more than the ideal stoichiometric fuel/air ratio is required for safety, and to reduce NOx emissions, but approximately 15% is adequate.

An often-stated rule of thumb is that boiler efficiency can be increased by 1% for each 15% reduction in excess air or 40°F reduction in stack gas temperature.

Do note that the combustion efficiency indicates only the amount of heat extracted from the fuel. It does not account for excess heating of combustion air, or losses from leaks or the boiler jacket, among other factors.

There is another term “Thermal Efficiency or Gross Efficiency” which accounts for other losses such as the radiation, convection, and blowdown losses. Gross efficiency of the boiler is the output (steam or water heat content and volume) divided by the fuel input (measured by a fuel meter at steady-state firing conditions). Thermal efficiency will always be lower than the combustion efficiency.

We will discuss these losses in the next chapter.

4.0. CHAPTER - 4: PERFORMANCE EVALUATION OF A BOILER

The performance of a boiler reduces with time due to poor combustion, heat transfer surface fouling, and poor operation and maintenance. The purpose of the performance test is to determine the actual performance and efficiency of the boiler and compare it with design values or norms. It is an indicator for tracking day-to-day and season-to-season variations in boiler efficiency and energy efficiency improvements. In this section, we will discuss the performance evaluation of fuel oil and gas-fired boilers.

4.1 Industry Recognized Efficiency Test Standards

The two most prominent industry-wide testing standards for boilers are ASME PTC 4 and BTS-2000. The Federal government requires that all packaged commercial space heating boilers meet federal minimum efficiency requirements when tested according to BTS-2000. The BTS-2000 Standard is designed to facilitate laboratory testing and allows a fair comparison of boiler efficiency ratings under standard conditions. There are no mandatory federal test procedures for boilers intended to provide heat for applications other than building heating.

ASME PTC 4 is a more appropriate test standard for industrial and utility boilers, particularly those firing solid fuels, and for determining boiler efficiency once the boiler is installed and operating.

4.1.1. ASME Standard: PTC-4-1 Power Test Code for Steam Generating Units

The standard for determining boiler efficiency in North America is the ASME Power Test Code (ASME PTC 4.1). As prescribed by the ASME Power Test Code, PTC 4.1, the fuel-to-steam efficiency of a boiler can be determined by two methods:

- a. The Direct Method: Where the energy gain of the working fluid (water and steam) is compared with the energy content of the boiler fuel.
- b. The Indirect Method: Where the efficiency is the difference between the losses and the energy input.

4.2 Direct Method for Estimating Boiler Efficiency

This is also known as the 'input-output method' because it only needs the useful output (steam) and the heat input (i.e. fuel) for evaluating the efficiency. This efficiency can be evaluated based on the ratio of the output-to-input of the boiler.

$$\text{Boiler Efficiency} = \frac{\text{Heat Output}}{\text{Heat Input}} \times 100$$

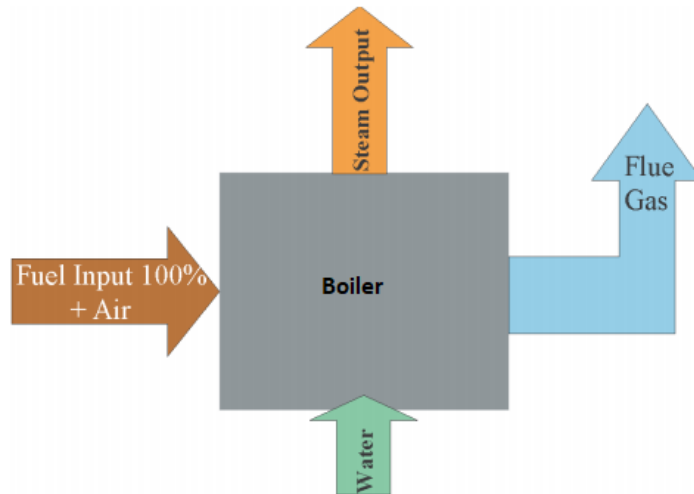

$$\text{Efficiency} = \frac{\text{Heat addition to Steam}}{\text{Gross heat in fuel}} \times 100$$

$$\text{Boiler Eff.} = \frac{\text{Steam flowrate} \times (\text{Steam enthalpy} - \text{feedwater enthalpy})}{\text{Fuel firing rate} \times \text{Gross calorific value}} \times 100$$

4.2.1. Measurements Required for Direct Method Testing

4.2.2. Heat input

Both heat input and heat output must be measured. The measurement of heat input requires knowledge of the heating value of the fuel and its flow rate in terms of mass or volume, according to the nature of the fuel.

For gaseous fuel: A gas meter of the approved type can be used, and the measured volume should be corrected for temperature and pressure. A sample of gas can be collected for heating value determination, but it is usually acceptable to use the heating value declared by the gas suppliers.

For liquid fuel: Heavy fuel oil is very viscous, and this property varies sharply with temperature. The meter, which is usually installed on the combustion appliance, should be regarded as a rough indicator only and, for test purposes, a meter calibrated for the particular oil is to be used and should be installed over a realistic range of temperature. Even better is the use of an accurately calibrated day tank.

4.2.3. Heat Output

There are several methods, which can be used for measuring heat output. With steam boilers, an installed steam meter can be used to measure flow rate, but this must be corrected for

temperature and pressure. In earlier years, this approach was not favored due to the change in accuracy of the orifice or venturi meters with flow rate. It is now more viable with modern flow meters of the variable-orifice or vortex-shedding types.

An alternative with small boilers is to measure feed water, and this can be done by previously calibrating the feed tank and noting down the levels of water during the beginning and end of the trial. Care should be taken not to pump water during this period. Heat addition for the conversion of feed water at inlet temperature to steam is considered for heat output.

In case of boilers with intermittent blowdown, blowdown should be avoided during the trial period. In case of boilers with continuous blowdown, the heat loss due to blowdown should be calculated and added to the heat in steam.

4.2.4. Merits and Demerits of Direct Method

Merits

- a. Plant people can quickly evaluate the efficiency of boilers
- b. Requires few parameters for computation
- c. Needs few instruments for monitoring

Demerits

- a. Does not give clues to the operator as to why the efficiency of the system is lower
- b. Does not calculate various losses accountable for various efficiency levels
- c. Evaporation ratio and efficiency may mislead if the steam is highly wet due to water carryover

4.3 Indirect Method for Estimating Boiler Efficiency

In the indirect method, the efficiency is estimated by evaluating all the losses occurring in the boiler. The following losses are applicable to liquid and gas fired boilers:

- a. L1 Loss due to dry flue gas (sensible heat)
- b. L2 Loss due to hydrogen in fuel (H_2)
- c. L3 Loss due to moisture in fuel (H_2O)
- d. L4 Loss due to moisture in the air (H_2O)
- e. L5 Loss due to carbon monoxide (CO)
- f. L6 Loss due to surface radiation, convection, and other unaccounted*.

*Losses are insignificant and difficult to measure.

The efficiency can be arrived at, by subtracting the heat loss fractions from 100.

$$\text{Boiler Efficiency} = 100 - (L1 + L2 + L3 + L4 + L5 + L6)$$

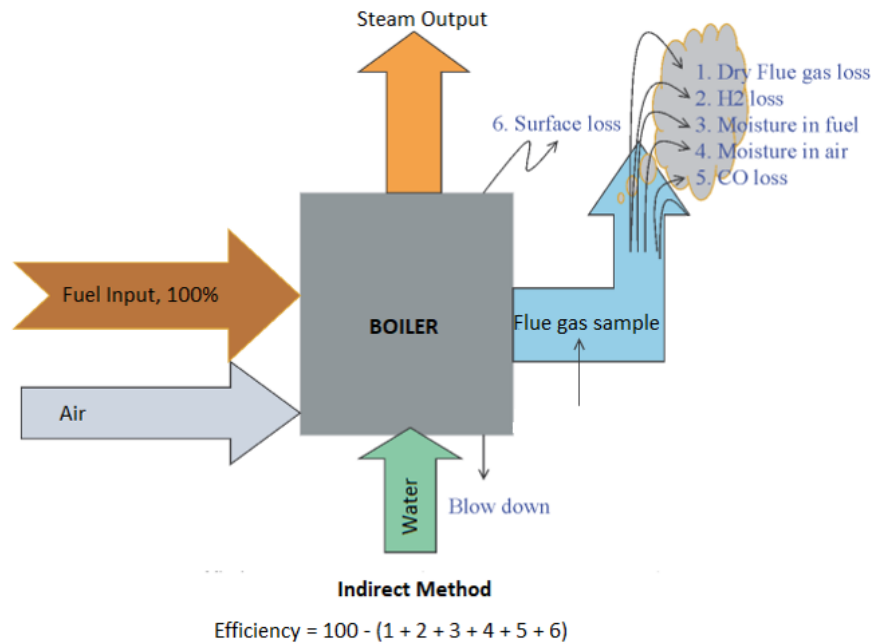

This method requires significantly more information from the operating boiler compared to the “Direct Method” of boiler efficiency calculation and is more time-consuming. Nevertheless, the “Indirect Method” has significant advantages over the “Direct Method” including:

- a. Less uncertainty (higher accuracy)
- b. Ability to pinpoint and quantify the areas of energy losses

4.4 Heat Losses in Boiler: Calculation and Formulas

4.4.1. L1: Dry Flue Gas or Stack Losses (LDG)

This is the biggest boiler loss and can be calculated as:

$$\text{LDG (\%)} = [\text{DG} \times \text{Cp} \times (\text{FGT} - \text{CAT})] \times 100 \div \text{HHV}$$

Where

- DG is the weight of dry flue gas, lb/lb of fuel
- Cp is the specific heat of flue gas, usually assumed to be 0.24
- FGT is the flue gas temperature, °F
- CAT is the combustion air temperature, °F
- HHV is the higher heating value of the fuel, Btu/lb.

The formula can be simplified to $\text{LDG, \%} = [24 \times \text{DG} \times (\text{FGT} - \text{CAT})] \div \text{HHV}$

If temperatures are measured in °C, other units remaining unchanged, the formula becomes

$$\text{LDG} = [43.2 \times \text{DG} \times (\text{FGT} - \text{CAT})] \div \text{HHV}$$

Note: Water vapor is produced from Hydrogen in fuel, moisture present in fuel and air during the combustion. The losses due to these components have not been included in the dry flue gas loss since they are separately calculated as a wet flue gas loss.

The weight of dry gas per lb of fuel, DG, varies with fuel composition and the amount of excess air used for combustion. For the normal case of no CO or unburned hydrocarbons it can be calculated as follows:

$\text{DG, lb/lb fuel} = (11\text{CO}_2 + 8\text{O}_2 + 7\text{N}_2) \times (\text{C} + 0.375\text{S}) \div 3\text{CO}_2$, where CO_2 , O_2 and N_2 are % by volume in the flue gas and C and S are weight fractions from the fuel analysis, i.e. lb/lb fuel.

N_2 is calculated as % by volume in the flue gas = $100 - \text{CO}_2 - \text{O}_2$

It is important to note that the foregoing equation requires the flue gas analysis to be reported on a dry basis; that is, the volumes of CO_2 and O_2 are calculated as a percentage of the dry flue gas volume, excluding any water vapor. This is because early gas analysis techniques employed wet chemistry, which condensed the water vapor in the process of taking the sample. Many modern analytical techniques, such as those employing infrared or paramagnetic principles, also measure on a dry gas basis because they require moisture-free samples to avoid damage to the detection cells. These analyzers are set up with a sample conditioning system that removes moisture from the gas sample. However, some analyzers, such as in-situ oxygen detectors employing a zirconium oxide cell, measure on a wet gas basis. Results from such equipment need to be corrected to a dry gas basis before they are used in the ASME equations. This is easily done using correction factors (CF) as follows:

$\%, \text{ dry basis} = \%, \text{ wet basis} \times \text{CF}$

Approximate values for CF, suitable for quick assessment of boiler efficiency, are:

Natural gas: $\text{CF} = 1.19$

No. 2 oil: $\text{CF} = 1.12$

No. 4 oil: $\text{CF} = 1.10$

Analysis

One can see from the equation that minimizing excess air (DG), reducing the flue gas temperatures (FGT) and raising the combustion air temperature (CAT) reduces dry flue gas losses (LDG).

Controlling excess air → A quality design will allow firing at minimum excess air levels of 10 - 15% (~3% of O₂). O₂ represents oxygen in the flue gas.

Low flue gas temperature (FGT) → Installing waste heat recovery equipment such as economizer and keeping boiler surfaces clean.

Raising combustion air temperature (CAT) → Preheating the combustion air by using preheater.

4.4.2. L2: Heat Loss Due to Evaporation of Water Formed due to H₂ in Fuel (LH)

The hydrogen component of fuel leaves the boiler as water vapor, taking away with it the heat corresponding to its conditions of temperature and pressure. The water vapor finally comes out to the chimney as a superheated steam at very low pressure but with a high temperature. Thus, heat is lost by sensible heating and evaporation of water. This loss is about 11 percent for natural gas and 7 percent for fuel oil.

Percentage of heat loss by evaporation of water due to the presence of hydrogen in fuel can be calculated using the Equation below:

$$LH (\%) = [900 \times H_2 \times (hg - hf)] \div HHV$$

Where

- H₂ is the weight fraction of hydrogen in the ultimate analysis of the fuel
- HHV is the higher heating value
- hg is the enthalpy in Btu/lb of water vapor at 1 psi and the flue gas temperature (FGT) in °F
- hf is the enthalpy of water at the combustion air temperature (CAT) in °F.

hg can be determined from steam tables or from the equation:

$$hg = 1055 + (0.467 \times FGT), \text{ Btu/lb}$$

hf can also be determined from steam tables, or from the simple relationship

$$hf = CAT - 32, \text{ Btu/lb}$$

Analysis

Knowing the flue gas temperature, combustion air temperature, and fuel analytical data, LH can be readily calculated. Unfortunately, there is not much the operator can do to reduce it. Since most of the lost heat is in the heat of vaporization, measures that reduce the flue gas temperature have only a small effect. One measure, particularly effective when firing natural gas is using

condensing heat exchanger, which recovers the heat of vaporization by converting the water vapor back to liquid form.

4.4.3. L3: Heat Loss Due to Moisture Present in Fuel (LMF)

During combustion, the moisture or liquid water present in the fuel leaves as a superheated vapor. This moisture loss is made up of the sensible heat to bring the moisture to the boiling point, the latent heat of evaporation of the moisture and the superheat required to bring this steam to the temperature of the exhaust gas. The amount of heat taken by the moisture is directly proportional to the amount of moisture present in the fuel.

The amount of heat loss due to moisture in fuel can be calculated using equation:

$$\text{LMF (\%)} = [100 \times M \times (h_g - h_f)] \div \text{HHV}$$

Where:

- M is the amount of moisture in fuel, lb/lb of fuel
- HHV is the higher heating value, Btu/lb
- h_g is the enthalpy in Btu/lb of water vapor at 1 psi and the flue gas temperature (FGT) in °F
- h_f is the enthalpy of water at the combustion air temperature (CAT) in °F.

Moisture in the fuel is determined from lab analysis of the fuel and can be obtained from the fuel supplier.

4.4.4. L4: Loss Due to Moisture in the Air (LMA)

Atmospheric air contains water vapor as a moisture. After combustion, water vapor present in the combustion air becomes superheated steam at the cost of combustion heat. Thus, certain amount of heat is lost due the presence of moisture in air.

The percentage of this loss due to moisture present in air can be calculated using Equation:

$$\text{LMA} = [m \times C_p \times (\text{FGT} - \text{CAT})] \times 100 \div \text{HHV}$$

Where,

- m is the mass of water vapor the air contains, lb/lb of dry air. The mass of vapor that air contains can be obtained from psychometric charts.
- C_p is the specific heat of superheated steam in Btu/lb °F
- FGT is the flue gas temperature, °F
- CAT is the combustion air temperature, °F

- HHV is the higher heating value of the fuel, Btu/lb.

This loss is very small usually less than 1% and is normally not calculated.

4.4.5. L5: Heat Loss Due to Incomplete Combustion (LCO)

Incomplete combustion of carbon could occur due to shortage of oxygen in the combustion chamber or poor distribution of fuel. The product of incomplete combustion is carbon monoxide which results in the liberation of only 52% of the total heat in the fuel. Thus, products formed by incomplete combustion could be burned again with further release of energy.

The heat loss due to incomplete combustion can be expressed by Equation below:

$$LCO (\%) = \frac{\%CO}{\%CO_2 + \%CO} \times 10160 \times Cb$$

Where:

- Cb = fractional carbon content

Analysis

Carbon in the fuel reacts with oxygen to form CO first, then CO₂, generating a total of 14,540 Btu's of heat per pound of carbon. If the reaction stops at CO because of insufficient O₂ or poor mixing of fuel and air, 10,160 Btu's of energy are lost.

Poor mixing of fuel and air at the burner. Poor oil fires can result from improper viscosity, worn tips, carbonization on tips, etc.

4.4.6. L6: Heat Loss Due to Radiation and Convection (LR)

The external surfaces of a shell boiler are hotter than the surroundings. The surfaces thus lose heat to the surroundings depending on the surface area and the difference in temperature between the surface and the surroundings. The heat loss from the boiler shell is normally a fixed energy loss, irrespective of the boiler output.

Normally surface losses are assumed based on the type and size of the boiler as given below:

- a. For industrial fire tube / packaged boiler = 1.5 to 2.5%
- b. For industrial water tube boiler = 2 to 3%
- c. For power station boiler = 0.4 to 1%

Since the boiler's surface area relates to its bulk, the relative loss is lower for a larger boiler and higher for a smaller boiler. Instead of making complex calculations, determine the radiation and convection loss using a standard chart available from the American Boiler Manufacturers Association (ABMA).

Analysis

With modern boiler designs, this may represent only 1.5 percent of the gross heating value at the full rating but will increase to around 6 percent if the boiler operates at only 25 percent output.

Repairing or augmenting insulation can reduce heat loss through boiler walls and steam piping.

4.4.7. Using Boiler Efficiency Data

The efficiency can be arrived at, by subtracting the heat loss fractions from 100.

Boiler Efficiency by indirect method = $100 - (\text{LDG} + \text{LH} + \text{LMF} + \text{LMA} + \text{LCO} + \text{LR})$

Caution:

The efficiency test does not account for:

- a. Standby losses. Efficiency test is to be carried out when the boiler is operating under a steady load. Therefore, the combustion efficiency test does not reveal standby losses, which occur between firing intervals.
- b. Blowdown loss. The amount of energy wasted by blowdown varies over a wide range.
- c. Soot blower steam. The amount of steam used by soot blowers is a variable that depends on the type of fuel.
- d. Auxiliary equipment energy consumption. The combustion efficiency test does not account for the energy usage by auxiliary equipment, such as burners, fans, and pumps.

4.5 Measurements Required for Performance Assessment Testing

In industrial steam systems, operating data measurements of process and utility variables typically consist of:

- a. **Temperature** - Temperature measurement is one of the most common measurements for steam system analysis. It can be done in several different ways and depending on the application and location of the measurement, it will require different types of temperature instruments. The temperature measurement portable instrumentation equipment required for an industrial steam system assessment is thermal imaging camera, infra-red temperature gun (or thermometer), hand-held digital thermometer, immersion temperature probe. Temperature measurements are required for:
 - Flue gas
 - Steam
 - Makeup water

- Condensate return
 - Combustion air
 - Fuel
 - Boiler feedwater
- b. **Pressure** - Pressure measurement using portable instrumentation in a steam system is much more difficult to do than temperature measurement since the steam or process fluid to be measured must be in contact with a pressure sensing device. Pressure measurements are required for:
- Steam
 - Fuel
 - Combustion air, both primary and secondary
 - Draft
- c. **Flow** - suitable devices include external clamp-on ultrasonic flow meters, electromagnetic flow. Flowmeter measurements are required for:
- Fuel
 - Steam
 - Feedwater
 - Condensate water
 - Combustion air
- d. **Combustion (Flue Gas) analysis** - The main purpose for undertaking a flue gas analysis is to determine the operating combustion efficiency (or flue gas losses) for the boilers. A significant part of the boiler efficiency is dependent on the combustion efficiency and estimating boiler efficiency (using the indirect method) will require the calculation of flue gas losses. Flue gas losses are dependent on the net flue gas temperature and the percent oxygen in the flue gas stream. The flue gas analysis allows the steam energy expert to calculate these losses.
- e. **Flue Gas Analysis** – is carried out for monitoring the excess air and stack losses. The following measurements are required:
- Percentage of CO₂ or O₂ in flue gas
 - Percentage of CO in flue gas
- f. **Water chemistry** - Water condition measurements are made for:
- Total dissolved solids (TDS)
 - pH

- Blowdown rate and quantity

g. Power production

The various parameters that were discussed above can be measured with the instruments that are given in the table below:

4.6 Measuring Instruments

No.	Name of the Instrument	Intended Use
1.	Flue Gas Analyzers	Used for optimizing the combustion efficiency by measuring/monitoring the oxygen and CO levels in the flue gas of boilers, furnaces etc. and calculation of CO ₂ percentage in excess air level and efficiency.
2.	Temperature Indicators	Used for measuring temperatures of gases/air, liquids, slurries, semi-solids, powders, etc. Using different types of probes.
3.	Infrared Thermometers	Used for measuring temperatures from a distance using infrared technology.
4.	Thermal Insulation scanner	Used for measuring the loss of energy in Kcal per unit area from hot/cold insulated surfaces. The total loss can be obtained by multiplying the total surface under study.
5.	Steam Trap Monitor	Used for performance evaluation of steam Traps.
6.	Conductivity Meter	Used for on the spot water analysis of the amount of dissolved solids in water.
7.	pH meter	Used for on the spot analysis of effective acidity or alkalinity of a solution/water. Acidity /alkalinity of water.
8.	Thermo-hygrometer	Used for measurement of air velocity & humidification, ventilation, Air-conditioning, and refrigeration systems, etc.

9.	Thermo-hygrometer	Used for measurement of humidity and temperature and the calculation of dew point to find out the heat being carried away by outgoing gases in industries. Where product drying requires hot air.
10.	Ultrasonic Flow Meter	Used for measurement of the flow of liquids through pipelines of various sizes through ultrasonic sensors mounted on the pipelines.
11.	U-Tube Manometer	Used for measurement of differential pressure.
12.	Digital Manometer	Used for measurement of differential pressure.
13.	Viscosity gauge	Used for measurement of differential viscosity.
14.	Used Lube Oil Test Kit	Used for testing lube oil.
15.	Non-Contact Tachometer	Used for measurement of the speed of rotation equipment.
16.	Demand Analyzer	Used for measurement and analysis of electrical load and demand control.
17.	Power Analyzer	Used for measurement and analysis of electrical power.
18.	Harmonic Analyzer	Used for analysis of harmonics in power system.
19.	Luxmeter	Used for measurement of illumination level.
20.	Clip-on Dig. Watt Meter	Used for measurement of power without interrupting the connections.
21.	Clip-on Dig. PF Meter	Used for measurement of power factor without interrupting the connection.
22.	Clamp-on amp. Meter	Used for measurement of current without Interrupting the connections.
23.	Digital Multimeter	Used for measurement of voltage. Current and resistance.

24.	Frequency Meter	Used for measurement of the power supply frequency.
-----	-----------------	---

When evaluating your boiler purchase, ask your boiler vendor to go through the fuel-to-steam efficiency calculation to verify that it is realistic and proven. Make sure the efficiency data you are using for your boiler evaluation is guaranteed, accurate and repeatable over the life of the equipment. Remember, the first cost is a very small portion of your boiler's total lifecycle cost.

Opportunities for efficiency improvement are related to reducing losses in steam generation, distribution, and use. The subsequent chapters describe the opportunities for improving the energy efficiency in steam generation, distribution, and end-use.

5.0. CHAPTER - 5: MEASURES TO REDUCE STACK LOSSES

Stack loss is the thermal energy loss due to the heat carried away (out of the chimney) by the hot flue gases. This loss is usually called "dry flue gas". Hotter stack temperatures and large quantities of excess air increase this loss.

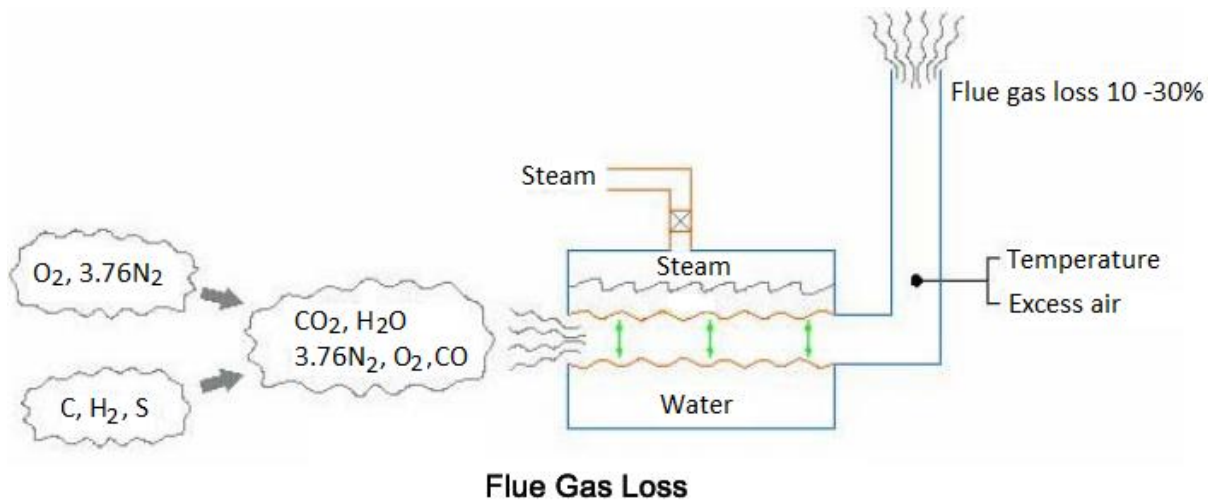

We learned in the previous chapter that the stack loss is typically the dominant loss for the boiler operation, ranging from 10% to more than 30% of the fuel input energy. In this chapter, we will study 12 efficiency tips to minimize the stack losses.

1. Efficiency Tip # 1: Preheat Boiler Feedwater with Economizer
2. Efficiency Tip # 2: Install Condensing Economizers
3. Efficiency Tip # 3: Preheat Combustion Air with Preheater
4. Efficiency Tip # 4: Regulate Excess Air
5. Efficiency Tip # 5: Upgrade Boilers with Energy-Efficient Power Burners
6. Efficiency Tip # 6: Equip Burner with Modulating Controls for Precise Air Fuel Ratio
7. Efficiency Tip # 7: Reduce Air Infiltration
8. Efficiency Tip # 8: Variable Speed Control for Fans, Blowers, and Pumps
9. Efficiency Tip # 9: Clean Boiler Heat Surfaces
10. Efficiency Tip # 10: Optimize Boiler Loading
11. Efficiency Tip # 11: Optimize Deaerator Operations
12. Efficiency Tip # 12: Investigate Fuel Switching

5.1 Factors Affecting Stack Losses

The largest portion of energy loss in a boiler occurs through the stack gas. The temperature and volume of stack gas leaving the boiler are the main factors for the heat loss assessment.

Four measurements are important:

- a. Flue gas temperature (FGT)
- b. Combustion air or the ambient temperature (CAT)
- c. Oxygen concentration in flue gas
- d. Combustible Concentration

5.1.1. Stack Temperature

Flue Gas Temperature (FGT) – The temperature of the flue (stack) gases exiting the process before and after implementation of the efficiency measure.

Combustion Air Temperature (CAT) – The temperature of the combustion air (which is the air mixed with fuel in the burner) before and after implementation of the efficiency measure.

Net Stack Temperature is the temperature differential between the flue gas temperature and the combustion air temperature (FGT – CAT).

Net stack temperature is the primary importance in evaluating stack losses because the inlet air temperature will have an impact on the final flue gas temperature. A boiler operating with very low inlet air temperature will experience a lower final flue gas temperature than the same boiler operating under similar load with a much higher inlet air temperature.

5.1.2. Oxygen Concentration in Flue Gas

Flue gas oxygen content is the field measurement indicating the combustion process has completed and oxygen remains in the flue gas. The flue gas oxygen content is commonly measured by two methods.

1. The first method yields a “full gas sample” (also known as “wet gas sample”) flue gas oxygen concentration. A wet based oxygen concentration identifies the amount of oxygen with respect to all the other flue gas constituents.
2. The second method yields a “dry gas sample”. A dry based oxygen concentration measures the oxygen content of the flue gas sample after the water vapor has been condensed and removed from the sample.

This measurement distinction is important for many reasons and it is critical to note that different instruments provide measurements with one or the other of these bases. In general, in-situ flue gas oxygen sensors measure full gas sample oxygen concentration. Alternately, most portable combustion analyzers measure dry gas samples.

5.1.3. Flue Gas Combustible Concentration

The final field measurement required to determine the stack loss is the flue gas combustibles concentration. An increase in flue gas combustibles generally indicates incomplete combustion due to poor burner performance or deficiency in combustion air.

The amount of combustible material in the exhaust gas varies significantly with respect to fuel type. Natural gas will generally have a much lower combustibles concentration than heavy fuel oil combustion. Typically, solid fuels will operate with the highest combustible concentration and generally require a higher amount of excess air (oxygen) for proper combustion. Generally, unburned fuel has a negligible impact on stack loss if it is less than 100 ppm concentration.

5.1.4. How to Determine Stack Losses?

Once you have all the measurements, the stack loss can be calculated from the table below:

As an example, consider a boiler burning natural gas. The final flue gas temperature has been measured to be 400°F and the ambient temperature has been measured as 70°F. The net stack temperature is 330°F (400°F - 70°F = 330°F).

Flue gas oxygen content was measured with a portable combustion analyzer as 8.0% dry gas sample.

The flue gas combustibles concentration measured to be ~0 ppm (negligibly small).

This information can be used along with a stack loss model for natural gas to determine the stack loss as shown below. In this example, the stack loss was determined as 19.7%.

If the other boiler losses (blowdown loss, shell loss, miscellaneous loss) were evaluated (or estimated) to be negligible, then the boiler efficiency would be 80.3% (100% - 19.7% = 80.3%).

Stack Loss Table for Typical Natural Gas

Flue gas O ₂ , Wet basis	Flue gas O ₂ , Dry basis	Net Stack Temperature [$\Delta^{\circ}\text{F}$] [Difference between flue gas exhaust temperature and ambient temperature]							
		180	230	280	330	355	380	430	455
1.0	1.2	13.6	14.7	15.8	16.9	17.4	18.0	19.1	19.6
2.0	2.4	13.8	14.9	16.1	17.2	17.8	18.4	19.5	20.1

3.0	3.6	14.0	15.2	16.4	17.6	18.2	18.8	20.0	20.6
4.0	4.7	14.2	15.5	16.7	18.0	18.7	19.3	20.6	21.2
5.0	5.8	14.5	15.8	17.2	18.5	19.2	19.9	21.2	21.9
6.0	6.9	14.8	16.2	17.6	19.1	19.8	20.5	22.0	22.7
7.0	8.0	15.1	16.6	18.1	19.7	20.5	21.2	22.8	23.6
8.0	9.1	15.5	17.1	18.8	20.4	21.2	22.1	23.7	24.6
9.0	10.1	16.0	17.7	19.5	21.2	22.1	23.0	24.8	25.7
10.0	11.1	16.5	18.4	20.3	22.2	23.2	24.2	26.1	27.1
Actual Exhaust T [°F]		250	300	350	400	425	450	500	525
Ambient T [°F]		70	70	70	70	70	70	70	70

Note: When determining heat loss from the flue, the temperature of the supply air (ambient air) is subtracted from the flue gas temperature. This gives the net temperature and accounts for the heat supplied to the system by the supply air.

5.2 Measures to Reduce Stack Losses

We have learned in the previous chapters that the flue gas loss is given by the equation:

$$\text{Dry flue gas loss} = [\text{DG} \times C_p \times (\text{FGT} - \text{CAT})] \times 100 \div \text{HHV}$$

Where,

- DG is the weight of dry flue gas, lb/lb of fuel
- C_p is the specific heat of flue gas, usually assumed to be 0.24
- FGT is the flue gas temperature, °F
- CAT is the combustion air temperature, °F
- HHV is the higher heating value of the fuel, Btu/lb.

One can see from the equation that the two factors can minimize the stack loss:

- a. Minimizing the flue gas temperature leaving the stack (FGT)
- b. Minimizing excess air (DG)

The stack temperature can be reduced by adopting the waste heat recovery equipment such as economizers and preheaters.

The excess air can be minimized by routine combustion analysis and utilizing efficient burner controls.

5.3 Efficiency Tip # 1: Preheat Boiler Feedwater with Economizer

An economizer is a heat exchanger that preheats feedwater to the boiler using heat from the exhaust gasses. Boiler flue gases are often rejected to the stack at temperatures more than 100°F to 150°F higher than the temperature of the generated steam. Generally, boiler efficiency can be increased by 1% for every 40°F reduction in flue gas temperature. By recovering waste heat, an economizer can often reduce fuel requirements by 5% to 10% and pay for itself in less than 2 years.

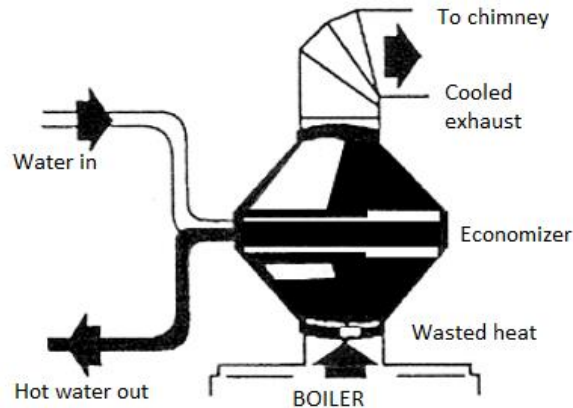

Heat Recovery Economizer

The table provides examples of the potential for heat recovery.

Recoverable Heat, MMBtu/h

Initial Stack Gas Temperature, °F	Boiler Thermal Output, MMBtu/hr			
	25	50	100	200
400	1.3	2.6	5.3	10.6
500	2.3	4.6	9.2	18.4
600	3.3	6.5	13.0	26.1

The temperature of the gases exiting the unit (FGT) should be as low as possible.

A stack temperature greater than 400°F indicates the potential for recovery of waste heat. The use of flue gas economizers should be considered in certain types of applications, particularly those in which high-pressure steam is used. A feedwater economizer is appropriate when the boiler capacity exceeds 100 horsepower, operating at pressures exceeding 75 psig or above, and that is significantly loaded all year long are excellent candidates for an economizer retrofit.

Caution

Although it is desirable to recover as much heat as possible from the boiler, care must be taken to avoid flue gas temperature reaching below the dew point of acids in flue gas. This minimum temperature limit depends on the sulfur content in the fuel. Condensation in the flue gas would form sulfuric acid which is very corrosive and would lead to metal deterioration and lower operational reliability of the boiler. In addition to sulfuric acid, further reduction in the stack gas temperature would lead to the formation of carbonic acid. This is not a major concern for short durations since carbonic acid is a weak acid but over time it will surely become an operational issue if the metallurgy is not properly configured for condensation in the stack gas.

Acid Dewpoint Temperature of Various Fuels

Fuel	Acid Dewpoint Temperature (°F)	Minimum Allowable Stack Temperature (°F)	Minimum Allowable Feed-water Inlet Temp (°F)
Natural Gas	150	250	210
#2 Oil	180	275	210
Low Sulphur Oil	200	300	220

The lowest temperature to which flue gases can be cooled depends on the type of fuel used: 250°F for natural gas and 300°F for low Sulphur fuel oils.

5.4 Efficiency Tip # 2: Install Condensing Economizers

The water vapor is produced because of combustion, which typically stays in the gaseous state and exits the flue gas. This water vapor contains a significant amount of energy which can be recovered if this water vapor is condensed.

There are commercially available heat recovery equipment which have been specifically designed for clean-burning fuels (natural gas, methane gas, propane, fuel oil, etc.) to recover this latent heat of water vapor from the flue gas. These units are typically referred to as condensing economizers. These economizers can improve boiler efficiency by more than 10%.

5.5 Efficiency Tip # 3: Preheat Combustion Air with Preheater

A combustion air preheater heats the combustion air by transferring energy from the flue gas in the flue gas. The heat exchange is identical to the feedwater economizer except that instead of the feedwater, it is the combustion air being heated. The net result is a reduction in fuel usage and hence, an increase in the boiler efficiency.

Fuel savings for different furnace exhaust gas temperatures and preheated combustion air temperatures can be found in the table below and can be used to estimate reductions in energy costs.

Percent Fuel Savings Gained from Using Preheated Combustion Air

Furnace Exhaust Temperature, °F	Preheated Air Temperature, °F					
	600	800	1,000	1,200	1,400	1,600
1,000	13	18	—	—	—	—
1,200	14	19	23	—	—	—
1,400	15	20	24	28	—	—
1,600	17	22	26	30	34	—
1,800	18	24	28	33	37	40
2,000	20	26	31	35	39	43
2,200	23	29	34	39	43	47
2,400	26	32	38	43	47	51

There are two types of air preheaters: recuperators and regenerators.

- a. Recuperators are gas-to-gas heat exchangers placed on the furnace stack. Internal tubes or plates transfer heat from the outgoing exhaust gas to the incoming combustion air while keeping the two streams from mixing.

- b. Regenerators include two or more separate heat storage sections, each referred to as a regenerator. Flue gases and combustion air take turns flowing through each regenerator, alternately heating the storage medium and then withdrawing heat from it. For uninterrupted operation, at least two regenerators and their associated burners are required: one regenerator is needed to fire the furnace while the other is recharging.

5.6 Efficiency Tip # 4: Regulate Excess Air

Excess air is the extra air supplied to the burner beyond the air required for complete combustion. There is a balance between losing energy from using too much air and wasting energy from running too richly in any combustion process. In most scenarios, a liquid and gas fuel burner achieve this desired balance by operating at 10% to 20% of the optimal theoretical air. For natural gas-fired burners, the stoichiometric air required is 9.4-11 ft³ / 1.0 ft³ of natural gas or approximately an air-to-gas ratio of approximately 10:1. In this case, there is an excess oxygen level of 2%.

Excess air is determined from the measured concentration of O₂ in the flue gas. A good approximation for excess air, expressed as a percent, can be estimated as below:

$$\% \text{ of excess air} = \frac{100 \times \%O_2}{(21 - \%O_2)}$$

The relation between % O₂ and flue gas and excess air is illustrated in Table below. The advantage of oxygen-based analysis is that it is the same for any fuel or fuel combination:

Oxygen content and excess air

% O₂	% Excess air
1	5
2	10.52
3	16.67
4	23.53
5	31.25
6	40
7	50
8	61.7

9	77
10	90.9
11	110

The effort, therefore, should be to operate the boiler with a minimum % O₂ in flue gases (excess air), eliminating all avenues of excess air used for combustion and in the flue gas path. *As for a general rule of thumb... every 1% reduction in excess air results in an approximately 0.6% rise in the efficiency.*

There are three main measures to reduce excess air:

- a. Retrofitting Power Burner– This measure is to reduce the combustion airflow at the burner.
- b. Adopting Automatic Modulating Control – This measure continuously modulates the air/fuel ratio by a combination of the fuel flow control valve and the flue gas oxygen monitor in the flue gas.
- c. Reducing Draft Leaks – This measure involves blocking leaks in a furnace, oven, or other process heating system where ambient air is drawn into the system due to a vacuum caused by an induced draft fan draft effect created by the stack height.

5.7 Efficiency Tip # 5: Upgrade Boilers with Energy-Efficient Power Burners

A boiler will run only as well as the burner performs. A poorly designed boiler with an efficient burner may perform better than a well-designed boiler with a poor burner.

Oil Fired Boilers

For oil-fired boilers, the oil burners are usually of the atomizing variety, that is, they provide a fine spray of oil. Several types of these oil burners exist:

- a. Gun type burners spray oil into a swirling air supply.
- b. Horizontal, rotary burners use a spinning cup to whirl oil and air into the furnace.
- c. Steam- or air-atomizing burners use high pressured air or 25 psig steam to break up the oil into fine droplets.

For modulating or high/low flame control applications, the rotary or steam/air-atomizing burners are most common.

Natural Gas Boilers

For natural gas-fired boilers, the two typical types of gas burners are the atmospheric burner and the power type burner.

- a. An atmospheric burner is one in which both the fuel and the air are delivered to the combustion chamber at atmospheric pressure.
- b. Power burners use a forced-draft fan to thoroughly mix air and gas and inject the mixture into the combustion chamber at a pressure higher than atmospheric pressure.

Replacing an atmospheric burner with a power burner allows for a significant reduction in excess air. This measure is preferred (over a damper on the combustion air) if the burner operates over a wide range of heat output (high turndown ratio).

The “turndown ratio” is the maximum inlet fuel or firing rate divided by the minimum firing rate. With proper design, most gas burners exhibit turndown ratios of 10:1 or 12:1. A higher turndown ratio reduces burner starts, provides better load control, and provides fuel savings. Since the power burner thoroughly mixes the fuel and air, it can be operated with less excess air to control emissions of CO, unburned hydrocarbons, and soot than atmospheric burners. An efficient power burner requires only 2% to 3% excess oxygen, or 10% to 15% excess air in the flue gas, to burn fuel without forming excessive carbon monoxide and provides the proper air-to-fuel mixture throughout the full range of firing rates, without constant adjustment.

5.8 Efficiency Tip # 6: Equip Burner with Modulating Controls for Precise Air Fuel Ratio

The following are three ways to control the output of a commercial boiler:

- a. On/off (cycling) control
- b. High-fire/low-fire control
- c. Modulating control

On/off (cycling) control is most common for small boilers up to 1,000,000 Btu/h capacity. The oil or gas burner cycles on and off to maintain steam pressure or water temperature. Cycling control causes losses in efficiency because of the cooling (which is necessary for safety) of the fireside surfaces by the natural draft from the stack during the off, pre-purge and post-purge cycles.

High-fire/low-fire burners provide fewer off-cycle losses since the burner shuts off only when loads are below the low-fire rate of fuel input.

Modulating control is used on most large boilers because it adjusts the output to match the load whenever the load is greater than the low-fire limit, which is usually not less than 15% of the full load capacity. Steam header pressure is measured to determine the volume of gas or oil admitted to the burner. If steam pressure decreases, the fuel flow controller will increase fuel flow for the boiler to generate more steam — restoring the steam pressure to the set point. Conversely, if steam pressure increases, fuel flow will be decreased to reduce steam production. As the fuel flow into the boiler changes combustion, airflow must correspondingly change to maintain proper combustion. Most burners use linkages that vary the position of the inlet air damper with natural gas supply either by positioning control or automatic control.

5.8.1. Positioning Control

Positioning control of combustion airflow is generally accomplished by mechanically linking the air-flow control device (damper) to the fuel-flow control device. It is not equipped with continuous flue gas oxygen measurement.

Typically, this type of control is based on a pressure controller observing steam pressure, which controls fuel flow into the boiler. As the steam pressure decreases, the controller will increase fuel flow to increase boiler steam output. Combustion airflow will be increased in a preset manner in response to the fuel flow setting. This type of control does not adjust combustion air based on flue gas oxygen content. The position of the fuel control device dictates the position of the airflow control device. Periodically, the relationship, position between the combustion air setting and the fuel control setting is verified and adjusted through flue gas oxygen content evaluation (and combustibles evaluation).

5.8.2. Automatic Modulating Control

The automatic control uses a combination of the fuel control valve and the oxygen sensor linked to the combustion air damper. Here, oxygen content is continually monitored, and the combustion airflow is trimmed to maintain required oxygen limits. The automatic control relies on microprocessor-based modulation, which is a much more effective and efficient excess air control compared to the positioning control.

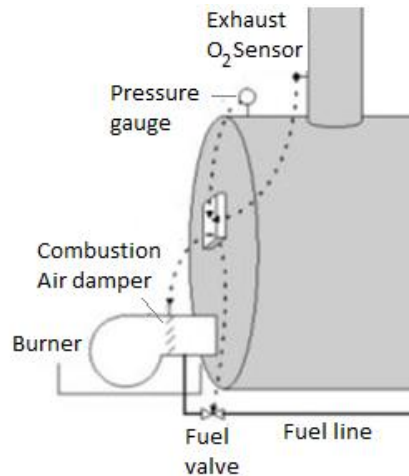

O₂ trim system to continually vary combustion air

Of course, continuous automatic combustion control requires more equipment and economic investment than positioning control—but efficiency is much improved.

The conventional fuels used in the combustion process are natural gas, oil (#2, 4, and 6), gasoline, propane, and coal—ratios for common gases, liquid, and solid fuels noted in Table below in terms of Oxygen content in flue gas:

Typical Flue Gas Oxygen Content Control Parameters

Fuel	Automatic Control Flue Gas O ₂ Content		Positioning Control Flue Gas O ₂ Content	
	Minimum	Maximum	Minimum	Maximum
Natural Gas	1.5	3.0	3.0	7.0
Fuel Oil Number #2	2.0	3.0	3.0	7.0
Fuel Oil Number #6	2.5	3.5	3.5	8.0

5.9 Efficiency Tip # 7: Reduce Air Infiltration

The pressure (or draft) in a large combustion chamber is maintained slightly negative (making it a vacuum) to prevent the combustion products and ash from being discharged from the combustion chamber into surrounding areas through inspection ports, doors, feeders, etc.

However, the ambient air flows into the combustion chamber through the inspection ports, doors, and feeders, and this air is heated to the flue gas temperature before it leaves the combustion chamber. The heat needed to raise the infiltration air from ambient temperature to the flue gas temperature is provided by the burner, and therefore reducing the infiltration air flow rate can save gas at the burner.

In an induced draft system, an induced draft fan draws the hot gases through the furnace. Control is accomplished by regulating the fan speed or through the operation of a damper.

In a natural draft system, the flue gases are vented due to the draft effect created by the stack height. Since the flue gases inside the stack are so much hotter than the ambient air, the flue gases are less dense than the ambient air outside the stack. The flue gases in the stack will rise, creating a vacuum (suction) in the combustion chamber, which will draw the combustion air and the infiltration air into the furnace. Control is accomplished through the operation of a damper on the combustion air.

5.10 Efficiency Tip # 8: Variable Speed Control (VSD) for Fans, Blowers, and Pumps

Generally, combustion air control is affected by throttling dampers fitted at forced and induced draft fans. Though dampers are simple means of control, they lack accuracy, giving poor control characteristics at the top and bottom of the operating range.

Variable speed drive (VSD) is the most efficient control method which provides the power to the fan motor that can overcome the system resistance at a given condition. Application of VSD is particularly effective if the load characteristic of the boiler is variable and frequent in low load conditions.

5.11 Efficiency Tip # 9: Clean Boiler Heat Surfaces

Fouling, scaling, and soot build up on heat transfer surfaces of boilers act as insulators and lead to reduced heat transfer. This results in lower heat transfer to the water in the boiler and higher flue gas temperature. If at the same load conditions and same excess air setting the flue gas temperature increases with time, this is a good indication of increased thermal resistance to heat transfer in the boiler.

There are two kinds of fouling: Soot and Scale.

5.11.1. Soot

Soot is the black smoke commonly seen in the exhaust of diesel trucks and is present whenever fuel oils or solid fuels are burned. Soot is caused primarily by incomplete combustion, deficient

air, a fouled or a defective burner, etc. Excessive soot is undesirable because it prevents good thermal conductivity. As a rule of thumb, a 1/32-inch layer of soot reduces boiler efficiency an estimated 2.5 percent, a 1/8-inch layer an estimated 8.5 percent.

5.11.2. Scale

The scale is a waterside fouling that happens when dissolved minerals in boiler water reach high levels and the minerals come out as a hard shell formed on the hot surfaces of the boiler. Scale build-up increases the thermal resistance between the hot combustion gasses and the steam and leads to increased tube wall temperatures and eventually a breakdown of the boiler tubes. Hence, waterside fouling has a direct impact on the reliability of boiler operations as well as the overall boiler efficiency. It is very important to perform inspections of boiler tubes for scale during the annual shutdown and undertake de-scaling of boiler tubes periodically. The best way to deal with scale is controlling the boiler water chemistry and is a direct function of boiler pressure, feedwater quality, and blowdown rate. Boiler water chemistry is controlled by a combination of proper boiler feedwater treatment and the dosage of chemicals.

5.12 Efficiency Tip # 10: Optimize Boiler Loading

The maximum efficiency of the boiler does not occur at full load but at about 2/3rd (65 -75%) of the full load. As the load falls, so does the value of the mass flow rate of the flue gases through the tubes. This reduction in flow rate for the same heat transfer area, reduces the exit flue gas temperatures by a small extent, reducing the sensible heat loss. However, below half load, most combustion appliances need more excess air to burn the fuel completely and increase the sensible heat loss.

Optimum efficiency occurs at 65-85% of full loads. If the steam demand is fluctuating, then:

- a. Consider installing modulating burners with a minimum firing rate of 25% to 33% of maximum output. Operation of boiler below 25% should be avoided.
- b. Consider adding steam accumulator. The purpose of a steam accumulator is to release steam when the demand is greater than the boiler's ability to supply at that time, and to accept steam when demand is low.

5.13 Efficiency Tip # 11: Optimize Deaerator Operations

The deaerator performs several functions in an industrial steam system. They include:

- a. Deaerating or removing dissolved oxygen from the feedwater (most important function)
- b. Preheating the make-up water

- c. May serve as a tank for mixing the returned condensate with make-up water
- d. Serving as a storage tank for feedwater and supplies the boiler feedwater pump

The deaerator operates at a fixed pressure. The main function of the deaerator – removal of dissolved oxygen from water – requires a stripping action. The stripping action is provided by the steam. Additionally, the steam preheats the makeup water which reduces the solubility of oxygen in the dissolved water further enhancing the stripping process. The deaerator requires a direct injection of live steam. The amount of steam used depends on:

- a. Deaerator pressure
- b. Amount of condensate returned and make-up water
- c. Temperature of condensate returned
- d. Temperature of make-up water
- e. Deaerator vent rate

As deaerator pressure is increased, more steam is needed, and the amount of steam vented (from the vents) also increases. Nevertheless, if higher temperature condensate is being returned, or if there is a waste heat recovery application that preheats the make-up water, then it may be beneficial to operate the deaerator at a higher pressure. Higher pressure operation will also require a smaller size deaerator for the same steam load. There have been several instances where processes change over time or are modified in industrial plants. This in turn may change the amount of condensate returned, the temperature of condensate, and make-up water preheating. Hence, it is very important to evaluate deaerator operations and ensure that it is operating at the lowest possible pressure and deaerating with the highest efficiency possible.

Additionally, reducing deaerator pressure will reduce the feedwater inlet temperature to a feedwater economizer and this may help reduce flue gas temperature which may lead to higher boiler efficiency. Care must be taken to ensure that lowering feedwater temperature doesn't reduce the flue gas temperature below its acid dew point.

5.14 Efficiency Tip # 12: Investigate Fuel Switching

Fuel selection can provide significant reductions in operating costs due to differences in energy costs and boiler efficiencies. Fuel efficiency will generally be an influencing factor when changing fuel. Sometimes energy costs and maintenance expenditures may be offsetting but this will not be evident unless additional due diligence is done on the optimizing opportunity. Additionally, environmental issues can become a significant concern associated with fuel selection. Each application will require an independent evaluation.

6.0. CHAPTER - 6: MEASURES TO REDUCE BLOWDOWN LOSSES

Blowdown is draining off a portion of water from the boiler for maintaining low concentrations of dissolved solids in the water. As steam boilers export relatively pure steam, the various compounds in the water and chemicals concentrate inside the boiler with time either in solution or suspension. Too great a concentration of total dissolved solids (TDS) will cause foaming, carryover, and depending upon the water level control system may cause false-positive level conditions. The level of dissolved solids is controlled by automatic or manual blowdown.

Most boilers employ two types of blowdown: surface and bottom. Surface blowdown removes dissolved solids which tend to accumulate near the top of the boiler where steam is formed. Bottom blowdown removes sludge that accumulates on the bottom of the boiler. Both practices result in unavoidable energy losses as hot water is wasted to the drain, and a balance must be maintained between acceptable results and energy losses. Skimming blowdown is best used as a continuous process, bottom blowdown is best done periodically as several short blowdowns. Continuous blowdown makes the use of heat recovery devices more feasible.

Total blowdown rates vary with the quality and quantity of boiler makeup water; however, the total rate of blowdown is typically between 4% and 8% of the steam generation rate.

Blowdown may be manual or automatic. Manual blowdown relies on intuition or periodic testing to determine when the concentration of contaminants is high enough to warrant blowdown. Manual blowdown virtually always results in either excess blowdown that wastes energy or insufficient blowdown that creates excess scale on heat transfer surfaces and reduces boiler efficiency. Automatic blowdown controls monitor the conductivity of the water in the boiler, and open the blowdown valve as needed to maintain the conductivity within a specified range.

Blowdown losses account for about 1–3% of the fuel consumption, but this energy loss can be reduced, thus, makeup water and chemical treatment costs can be saved by optimizing blowdown rate. In this section, we will discuss three (3) techniques to minimize blowdown losses:

1. Efficiency Tip # 1: Install Automatic Blowdown Controller
2. Efficiency Tip # 2: Improve Water Treatment Process
3. Efficiency Tip # 3: Recover Waste Heat from Blowdown

6.1 Why the boiler must blowdown?

Essentially, the feed water contains certain impurities and amounts of water treatment chemicals. As the water boils into steam, the remaining water becomes more concentrated and

contaminated, in the forms of both dissolved solids in solution as well as the suspended solids. This is indicated by the rise in conductivity (TDS, the total dissolved solids).

To maintain the proper condition of a boiler, the concentrated solutions inside the boiler water must be limited by regularly conducting a blowdown. Failure to perform, the blowdown may result in the following problems:

- a. Scale build-up inside the boiler reducing efficiency with the potential for overheating of the heat transfer surfaces which can lead to catastrophic failure.
- b. Internal corrosion of the boiler shell and heating surfaces.
- c. Carryover of dissolved solids into the steam system.
- d. False-positive water level indication, increasing the risk of a potentially dangerous low-water incident, e.g., due to foaming with certain types of level control.
- e. A build-up of sludge causing overheating of the metal surfaces with the possibility of cracks forming at tube ligaments or even furnace collapse.

Note however that although blowdowns are an absolute necessity for the operation of a boiler, it is important that one realizes that, depending on the pressure, each blowdown decreases the efficiency of the boiler.

6.1.1. What are the control standards of the boiler water?

The common impurities with respect to steam boilers that are present in water are:

- a. Salts of calcium and magnesium, which are responsible for hardness in water
- b. Chlorides
- c. Ammonium salts and their products of oxidation, nitrites and nitrates
- d. Traces of heavy metals such as lead or copper
- e. Dissolved gases, such as oxygen and carbon dioxide

Control standards of a boiler' s discharge and feed water are as follows:

Item	Feed water	Boiler water
Conductivity: $\mu\text{S/cm}$	<400	7,000
pH	8.5-9.5	10.5-12.0
Phosphate: mg/kg	-	30-60
Silica: mg/kg	-	<150
Hardness: PPM	<2	-

6.1.2. How to control the blowdown ratio?

The blowdown rate depends on the boiler type, operating pressure, water treatment, and quality of makeup water, it could be in the range of 4–10% of boiler feed water flow rate.

The operator should take a sample of boiler water for a conductivity test. If the test result showed a lower concentration than the standard, the operator would reduce the blowdown volume. Since the change in steam usage also affects the change in solution concentration, the conductivity test should be done as often as every shift.

6.2 Efficiency Tip # 1: Improve Water Treatment Process

One of the most critical factors affecting blowdown volume is the quality of feed water, which is the mixture of the makeup water and the returned condensate. As a first choice, ensure maximum condensate recovery since condensate is the purest form of water, and this would help reduce dependence on make-up water and blowdown requirements.

Second, the makeup water must be treated and conditioned before it is added to the system. The water treatment process for a steam boiler is usually in two stages – external or internal treatment:

6.2.1. External Treatment

The table below gives a brief description of the common primary water treatment systems in use.

External treatment method	Purpose
Filtration	The removal of organic and inorganic solid particles
Base exchange softening	To convert calcium and magnesium salts, by ion exchange, to sodium salts. This removes hardness which causes the formation of hard scale.
Reverse osmosis (RO)	To reduce total dissolved solids (TDS) and silica by membrane filtration.
De-alkalization	To reduce the total dissolved solids (TDS) by the removal of alkalinity.
Demineralization	To reduce/remove total dissolved solids (TDS) and silica by ion exchange.

6.2.2. Internal Treatment

Sodium carbonate, sodium aluminate, sodium phosphate, sodium sulfite, and compounds of vegetable or inorganic origin are used for treatment. Internal treatment alone is not recommended.

6.1 Efficiency Tip # 2: Install Automatic Blowdown Controller

In most circumstances, manual blowdown leads to excessive blowdown and this is a large energy loss. It can also result in very poor boiler water chemistry control leading to issues with reliable boiler operations. Installing an automatic boiler blowdown controller allows for the minimum and exact amount of blowdown that is required for reliable boiler operations thereby, reducing unnecessary energy losses.

An automatic boiler blowdown controller monitors boiler water conductivity (TDS) continuously, in real-time, and controls a modulating or an ON/OFF valve to maintain the required blowdown.

6.2 Efficiency Tip # 3: Recover Waste Heat from Blowdown

Blowdown contains energy, which can be recovered and recycled to heat boiler feed water and supply low-grade heating. Any boiler with a significant makeup (say 5%) is a candidate for blowdown waste heat recovery.

Two techniques are used to recover heat from boiler blowdown water and condensate:

- a. Flash steam - When the high pressure, hot blowdown water is discharged into the atmosphere at normal pressure, some part of it could boil into steam as “flash steam.” Flash steam vessels can be used to separate ‘flash steam’ which forms at points where boiler pressure is reduced. This flash-steam is clean and can feed the low-pressure steam header or supply steam to the deaerator or feedwater heating system. The liquid that remains in the flash-vessel is at the saturation temperature ($> 100^{\circ}\text{C}$) and can still be used to preheat make-up water in the make-up heat exchanger. The blowdown water is eventually discharged from the system at a temperature very close to the make-up water (or ambient) temperature.
- b. Heat exchangers can be used to transfer heat from boiler blowdown water or condensate to a clean water stream for further use. Heat recovery from boiler blowdown is most effective where there is a continuous water flow, such as that resulting from the use of automatic boiler blowdown control equipment.

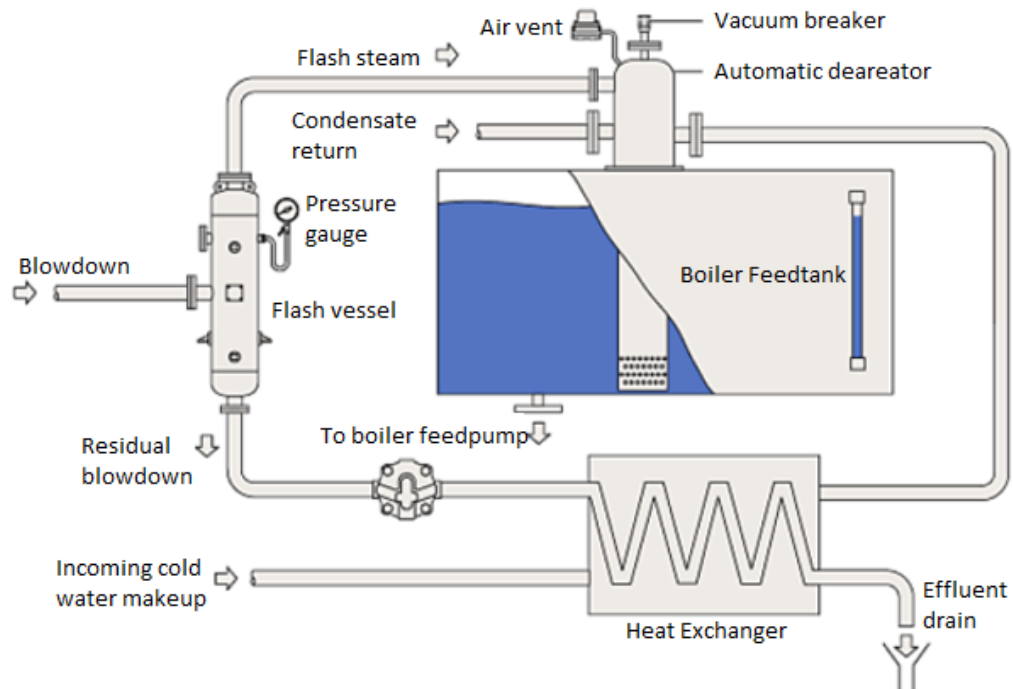

Heat Recovery from Blowdown

The typical uses for waste heat include:

- Heating of combustion air
- Makeup water heating
- Boiler feedwater heating
- Appropriate process water heating
- Domestic water heating

7.0. CHAPTER - 7: MEASURES TO IMPROVE STEAM DISTRIBUTION EFFICIENCY

Once the steam leaves the boiler, it flows through the distribution system, which contains pipes, valves, and backpressure turbines. An efficient distribution system provides the appropriate amount of steam at the right temperatures and pressures to each end use.

In this chapter, we will discuss Eleven (11) efficiency tips for proper steam distribution.

1. Efficiency Tip # 1 Optimize Boiler Steam Pressure
2. Efficiency Tip # 2 Reducing the Work done by Steam
3. Efficiency Tip # 3 Optimize Steam Piping Design
4. Efficiency Tip # 4 Adopting Good Layout Practices
5. Efficiency Tip # 5: Repair Steam Leaks
6. Efficiency Tip # 6: Minimize Vented Steam
7. Efficiency Tip # 7: Insulate Steam Piping, Valves, Fittings, and Vessels
8. Efficiency Tip # 8: Isolate Steam from Unused Lines
9. Efficiency Tip # 9: Drain Condensate from Steam Distribution
10. Efficiency Tip # 10: Switch from Steam to Air Atomization
11. Efficiency Tip # 11: Providing Dry Steam for the Process

7.1 Efficiency Tip # 1 Optimize Boiler Steam Pressure

Boilers are generally designed to operate at a specific pressure. For safety reasons, boilers should never be operated above the rated pressure. If the pressure of steam needed at the application is less than the rated pressure of the boiler, the boiler can be operated at less than the design pressure, or the boiler can be operated at the design pressure and the pressure of steam reduced through a valve located between the boiler and the application. Operating at a lower pressure will slightly increase the efficiency of the boiler because of the decreased steam temperature and subsequent boiler skin losses. Savings may be as much as 1 or 2 percent, but actual savings depend on the starting pressure and the pressure reduction that is realized. For example, a 50 psi drop from 150 psig saturated steam will reduce the steam (and stack) temperature by 28°F, saving approximately 0.7 percent. A 50 psi drop from 400 psig saturated steam, however, will result in only a 12°F drop for an approximate 0.3 percent saving.

Caution: Note: It is sometimes thought that running a steam boiler at a lower pressure than its rated pressure will save fuel. This logic is based on more fuel being needed to raise steam to a higher pressure. Whilst there is an element of truth in this logic, it should be remembered that it

is the connected load, and not the boiler output, which determines the rate at which energy is used.

Care should be taken of the adverse effects of pressure reduction, such as water carryover from the boiler owing to pressure reduction and reduced boiler heating capacity. Some other important advantages of generating and distribution steam at higher pressure include:

- a. The thermal storage capacity of the boiler is increased, helping it to cope more efficiently with fluctuating loads, minimizing the risk of producing wet and dirty steam.
- b. Smaller bore steam mains are required, resulting in lower capital cost, for materials such as pipes, flanges, supports, insulation, and labor. A kilogram of steam at a higher pressure occupies less volume than at a lower pressure. It follows that, if steam is distributed at a high pressure, the size of the distribution mains will be smaller than that for a low-pressure system for the same heat load.
- c. A primary advantage of operating the boiler at the design pressure and then reducing the pressure through a valve is that the steam exiting the valve will be slightly super-heated and drier at the point of use. *Pressure should be reduced in stages, and no more than a 20 percent reduction should be considered.*

These advantages usually negate any potential savings. The author believes that the steam boilers should be operated at their design pressure.

7.2 Efficiency Tip # 2 Reducing the Work done by Steam

Where steam is used for drying and heating, it shall be used to do no more work than is necessary. For example, if any product is to be dried say laundry clothes, squeeze as much water as possible from the wet material, before being heated up in a dryer using steam. Hydro extractors, spin dryers, squeeze or calendar rolls, presses, and other equipment can be used in many drying applications to remove the mass of water.

Air–heater batteries, for example, which provide hot air for drying, will use the same amount of steam whether the plant is fully or partly loaded. So, if the plant is running only at 50% load, it is wasting twice as much steam (or twice as much fuel) as is necessary.

By reducing work done by steam, energy saving can be achieved by the following measures:

- a. Reduction in operating hours
- b. Reduction in the steam quantity required per hour
- c. Use of more efficient technologies

- d. Avoiding part-load operations
- e. Minimizing wastage.

7.3 Efficiency Tip # 3 Optimize Steam Piping Design

Proper sizing of steam pipelines helps in minimizing pressure drop. The recommended velocities for various types of service are:

- e. Superheated: 9000 - 14000 ft/min
- f. Saturated: 4800 – 7200 ft/min
- g. Wet or Exhaust: 3600 – 6000 ft/s
- h. Pressure drop, as a rule, should not exceed 1 psig/100 ft. length.

Pipes carrying steam are generally made up of steel.

The steam flow – velocity chart and steam pressure – velocity chart, shown below are a great aid to pipe sizing.

Example using Steam Velocity Chart:

Upstream steam pressure = 100 psig

Downstream steam pressure after control valve = 25 psig

Steam flowrate = 1000 lb/hr

Determine pipe size required.

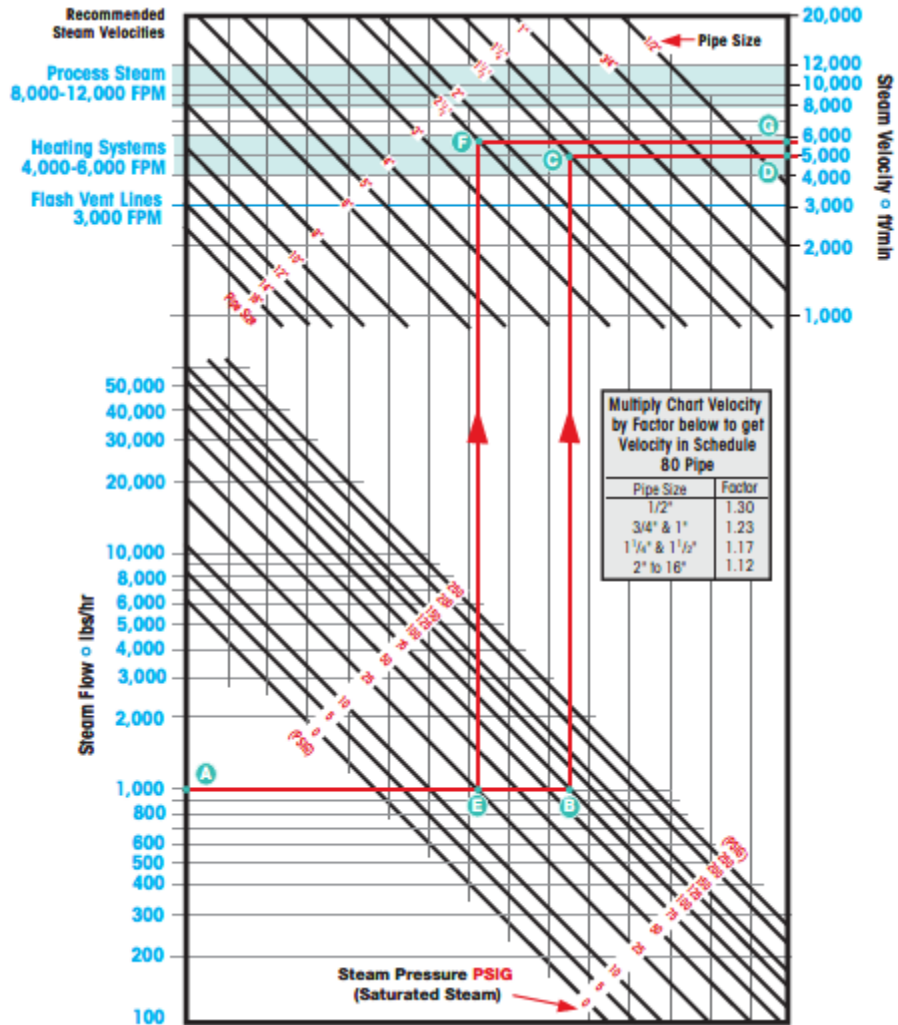

Solution

Upstream Piping:

Enter Velocity Chart at **A** 1000 lbs/hr. Follow the line to **B** 100 psig Inlet Pressure. Follow line vertically upwards to **C** 1½" Pipe Diameter. Steam Velocity at **D** shows 4800 ft/min.

Downstream Piping:

Enter Velocity Chart at **A** 1000 lbs/hr. Follow the line to **E** 25 PSIG Outlet Pressure. Follow line vertically upwards to **F** 2½" Pipe Diameter. Steam Velocity at **G** shows 5500 ft/min.

Another pressure-velocity chart could be used to validate the pressure drop.

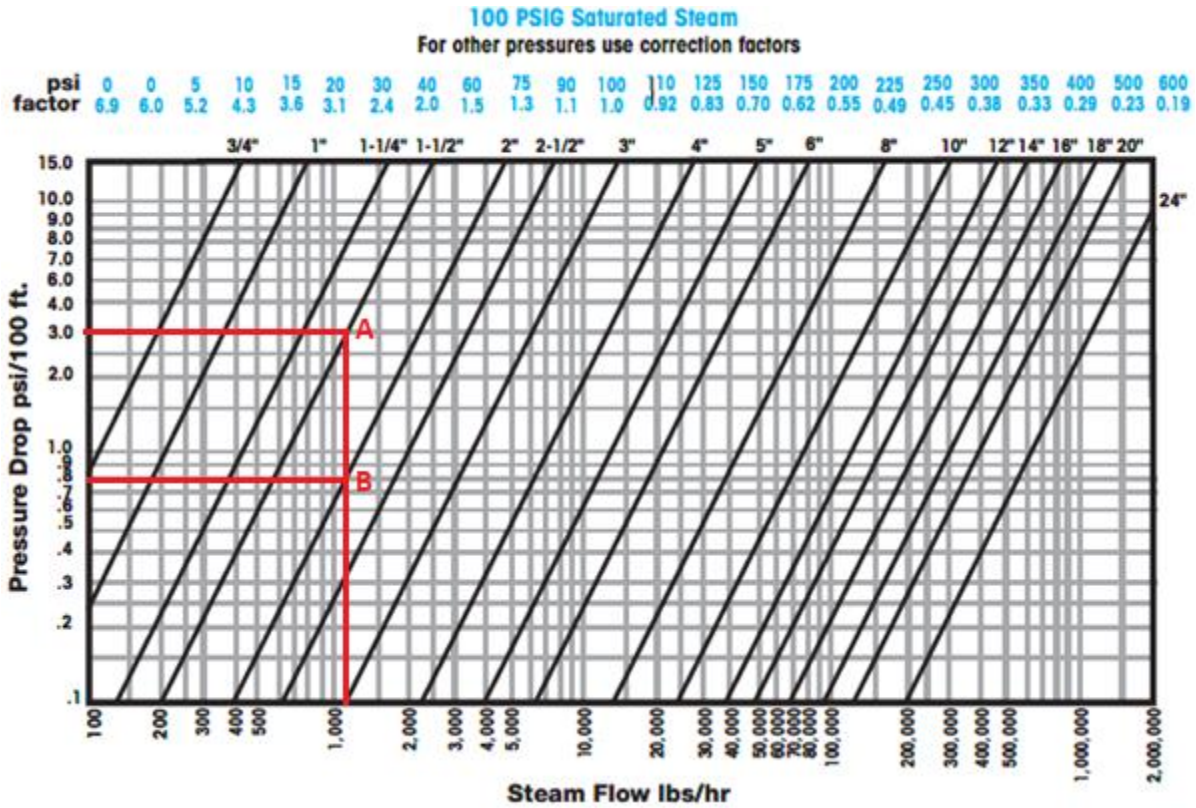

Enter pressure-velocity chart at **A** 1000 lbs/hr and 1½” pipe diameter. Follow towards the y-axis and read the pressure drop as 3 psig.

Enter pressure- velocity chart at **B** 1000 lbs/hr and 2” pipe diameter. Follow towards the y-axis and read the pressure drop as 0.8 psig.

Obviously, a bigger size pipe (2”) will have a lower pressure drop in line with the recommended guideline of less than 1 psig per 100 ft. A higher pipe size will reduce the pressure drop and thus the energy cost. However, a higher pipe size will increase the initial installation cost.

By use of smaller pipe size, even though the installation cost can be reduced, the energy cost will increase due to higher-pressure drop. Thus, optimum sizing is necessary. (Pressure drop change is inversely proportional to the 5th power of diameter change).

The chart can be used for pressures other than 100 psig by using the multiplication factors shown.

7.4 Efficiency Tip # 4 Adopting Good Layout Practices

Here are few good practices:

- a. Pipe redundancy is to be avoided in steam distribution since it leads to significant losses. All redundant pipelines must be eliminated; this could reduce steam distribution losses significantly.

- b. Provisions need to be made for proper draining of condensate. For example, a 4-inch well-lagged pipe, 100 feet in length, carrying steam at 100 psi pressure can condense nearly 20 lb/hr of condensate water in the pipe unless it is removed from the pipe through traps.
- c. The pipes should run with a fall (slope) of not less than $\frac{1}{2}$ inch for every 10 ft. distance, in the direction of flow.

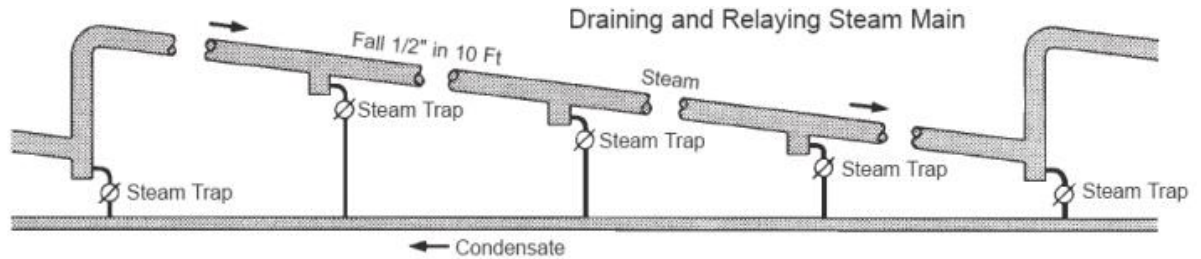

- d. Branch line connections taken from the top of the main steam line carries the driest steam.

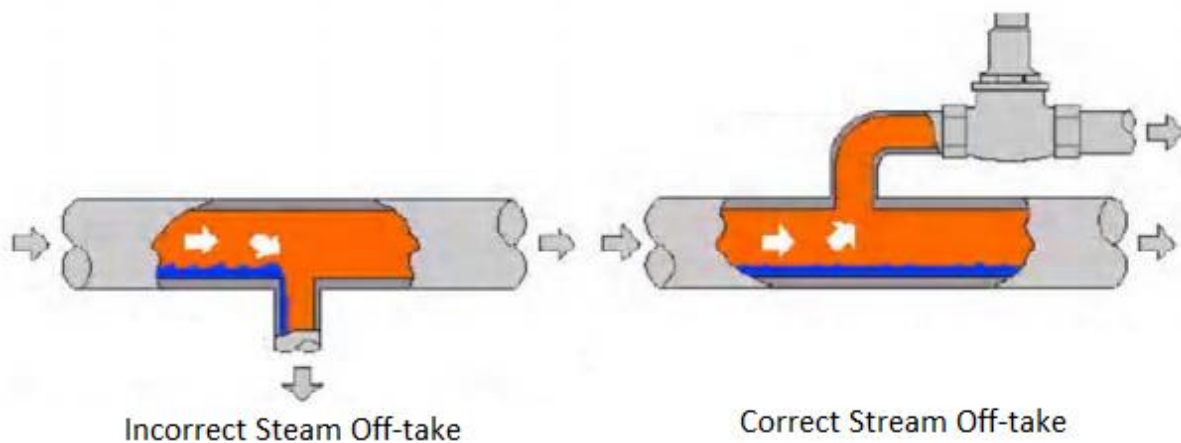

- e. Drain pockets should be provided every 100 to 150 ft and at any low point in the pipe network. Drain points help in removing water in the pipes due to the condensation of steam. The presence of water in steam is undesirable as it causes water hammer, leading to damage to steam pipes and eventually leakages. Steam traps must be provided at the drain points to avoid leakage of steam.
- f. Expansion loops are required to take care of the expansion of pipes when they get heated up.
- g. Automatic air vents should be fixed at the dead ends of steam mains, to allow removal of air, which will tend to accumulate.
- h. Steam pipes should be laid along the shortest possible distance.

7.5 Efficiency Tip # 5: Repair Steam Leaks

Steam leakage occurs from pipes, flanges, valves, connections, traps, and process equipment. It can be substantial for some steam distribution systems.

A continuous maintenance program based on finding and eliminating steam leaks is essential to the efficient operation of a steam system. Most times, such maintenance programs are questioned in the industrial plant with regards to their cost-effectiveness and overall impact on operations. But it has been observed in all instances that having a steam leaks management program can be very beneficial both economically as well as from a reliable operations perspective for an industrial plant.

The amount of steam leaking from various openings depends on the size of the opening and the working pressure and is estimated using a variant of the Napier formula:

$$\text{Steam Flow (lb/hr)} = 24.24 \times P_a \times D^2$$

where:

- $P_a = P_{\text{gage}} + P_{\text{atm}}$
- $P_a = \text{Absolute Pressure, psia}$
- $P_{\text{gage}} = \text{Gage Pressure, psig}$
- $P_{\text{atm.}} = \text{Atmospheric Pressure, psi} = 14.696 \text{ psi}$
- $D = \text{Diameter of Orifice, in.}$

For example:

$$P_{\text{gage}} = 5 \text{ psig}$$

$$P_a = 19.696 \text{ psia}$$

$$D = 0.1875 \text{ in}$$

$$W = 24.24 \times 19.696 \text{ psia} \times (.1875 \times .1875) = 16.78 \text{ lbs/hr}$$

By determining the amount of steam that escapes, it is possible to determine the financial loss as below:

$$Q = \frac{L \times H \times E \times 10^{-6} \times C}{BE}$$

where:

- $Q = \text{Energy Lost (\$)}$
- $L = \text{Lb/Hr of steam lost} = 16.78 \text{ lbs/hr (0.187" orifice, 5 psig)}$

- H = Hours in heating season = 5,808
- E = Latent heat of steam at 5 psig = 960.8 Btu/lb
- 10^{-6} = MMBtu/Btu
- C = Cost of gas per million Btu = \$6.23
- BE = Boiler Efficiency = 80%

$$Q = (16.78) (5,808) (960.8) (10^{-6}) (6.23)/0.80 = \$729.20$$

Regular leakage monitoring and rectification is one of the major steam economy measures. The table below shows the steam loss through orifices discharging to the atmosphere.

Orifice Diameter (inches)	Steam Flow, lb/hr, when steam gauge pressure in psi is;									
	2	5	10	15	25	50	75	100	125	150
1/32	0.40	0.47	0.58	0.70	0.94	1.53	2.12	2.72	3.31	3.90
1/16	1.58	1.86	2.34	2.81	3.76	6.13	8.49	10.86	13.23	15.59
3/32	3.56	4.20	5.26	6.33	8.46	13.78	19.11	24.44	29.76	35.09
1/8	6.32	7.46	9.35	11.25	15.03	24.50	33.97	43.44	52.91	62.38
1/4	25.29	29.84	37.41	44.99	60.14	98.01	135.89	173.76	211.64	249.51

7.6 Efficiency Tip # 6: Minimize Vented Steam

Air venting in a steam system is required because air is an insulator.

Steam venting happens when steam header pressure limits are reached, and the safety relief valves or other pressure controlling devices open vent steam to the ambient from the steam header. This typically happens due to steam unbalance on the headers when more steam is being generated than needed by the end-user processes.

The vent losses are like what we have calculated earlier for steam leaks.

7.7 Efficiency Tip # 7: Insulate Steam Piping, Valves, Fittings, and Vessels

Uninsulated steam pipes, condensate return pipes, condensate return tanks, deaerator tanks and process tanks lose heat to the surrounding by convection and radiation. Insulating these surfaces is extremely important for the following reasons:

- a. Plant personnel safety
- b. Minimizing energy losses
- c. Better process control by maintaining process temperatures at a constant level
- d. Protecting equipment, piping, etc. from ambient conditions and fire
- e. Absorbing vibration and preserving overall system integrity

A thermal insulator such as Glass wool, Calcium Silicate, or Rockwool is characterized by a low thermal conductivity. One rule of thumb is that any surface above 120°F should be insulated, including boiler surfaces, steam or condensate piping, and fittings. Removable insulating jackets are available for valves, flanges, pressure-reducing valves, steam traps, and other fittings. Note that a 6-inch gate valve may have more than 6 square feet of surface area over which to radiate heat from the system.

A good way to make the calculations required to estimate the heat loss per foot of pipe is to use the Best Practices Steam 3E-Plus, developed by the North American Insulation Manufacturers Association (NAIMA).

The software is free and is available at www.eere.energy.gov/industry/bestpractices/, www.naima.org, or www.pipeinsulation.org.

7.8 Efficiency Tip # 8: Isolate Steam from Unused Lines

As industrial processes change, steam demand varies, and sometimes steam is no longer required for a particular process, facility, or air-handler. Nevertheless, the steam lines are still in place and contain live steam till the first block (isolation) valve of the process end-use. There are also times when certain equipment is decommissioned and will never be used again but the steam lines to that equipment are still connected to the live steam headers and are hot.

From an energy and cost savings perspective, isolating steam from unused lines would:

- a. Eliminate heat transfer losses.
- b. Eliminate steam leaks.
- c. Eliminate any condensate formed in the headers which may lead to water hammer.
- d. Reduce maintenance requirements of steam system components in that section.

7.9 Efficiency Tip # 9: Drain Condensate from Steam Distribution

The steam distribution system can be extensive and there could be miles of steam piping in an industrial plant. Even when the steam lines are well insulated there is a certain amount of heat loss that exists which could lead to condensation in the steam headers especially for saturated steam systems.

Condensate that is drained from the steam headers can be flashed in a flash tank/separator vessel to a lower pressure steam header. The remainder of the condensate can either be sent back to the boiler plant directly or to a cascade condensate return system. It is very important to identify potential opportunities in the steam distribution area where condensate can and should be collected and returned to the boiler plant.

7.10 Efficiency Tip # 10: Switch from Steam to Air Atomization

Any steam-atomized burner shall be replaced with air atomization. The energy to produce the air is a tiny fraction of the energy in the fuel, while the energy in the steam is usually 1% or more of the energy in the fuel. Check economics to see if the satisfactory return on investment is available.

7.11 Efficiency Tip # 11: Providing Dry Steam for the Process

- a. As a rule, the steam should always be generated and distributed at the highest possible pressure but utilized at as low a pressure as possible since it then has higher latent heat.
- b. Almost all heat transfer processes call for dry saturated steam. Disadvantages of allowing wet steam include lower heat content, extended process time, irregular heating, creation of barriers to heat transfer, and overloading of steam traps. At the same time, superheated steam is not desirable for process heating because of its poor heat transfer coefficient, and it also takes time to give up superheat by conduction.
- c. To ensure dry steam for processing, steam separators may be fitted appropriately at the steam head and near steam use equipment.
- d. The latent heat in steam reduces as the steam pressure increases. It is this latent heat of steam that takes part in the heating process when applied to a direct heating system. Thus, it is important that its value be kept as high as possible. This can only be achieved if we try to obtain lower steam pressures.
- e. However, it can also be seen from the steam tables that the lower the steam pressure, the lower will be its temperature. Since temperature is the driving force for the transfer of heat at lower steam pressure, the rate of heat transfer will be slower and the processing time

greater. In equipment where fixed losses are high (e.g., big drying cylinders), there may even be an increase in steam consumption at lower pressures due to increased processing time. There are, however, several items of equipment with which one can profitably go in for lower pressures and realize the economy in steam consumption without materially affecting production time. Depending on the equipment design, the lowest possible steam pressure with which the equipment can work should be selected without sacrificing either production time or steam consumption.

8.0. CHAPTER - 8: MEASURES TO IMPROVE STEAM END-USE EFFICIENCY

Steam can be used for numerous different processes and applications. Some end uses of steam are for process heating, mechanical drive, chemical reactions, and separation of hydrocarbon components. End-use components include heat exchangers, turbines, strippers, chemical reaction vessels, and fractionating towers.

For industrial process heating system, the best quality of steam is the dry saturated steam because it has a very good heat transfer coefficient and has very high latent heat of vaporization. It is a very efficient mode of heat transfer.

As the steam moves through a distribution system or once the steam has transferred its thermal energy it condenses into liquid water called “condensate”. This condensate is an excellent source of boiler feed water as it is the purest form of water (distilled) in the plant. It has a significant amount of economic value because:

- a. Condensate is much hotter than make-up water and hence, has significant thermal energy. Significant fuel savings occur as most returned condensate is relatively hot (130°F to 225°F), reducing the amount of cold makeup water (50°F to 60°F) that must be heated.
- b. Condensate doesn't need any chemical water treatment and it reduces water treatment and makeup water costs. Boiler water cycles of concentration can be increased, and blowdown amounts can be reduced with its use.
- c. Less condensate discharged into a sewer system reduces disposal costs.

A simple calculation indicates that energy in the condensate can be more than 10% of the total steam energy content of a typical system. The graph shows the heat remaining in the condensate at various condensate temperatures, for a steam system operating at 100 pounds per-square-inch-gauge (psig), with makeup water at 55°F.

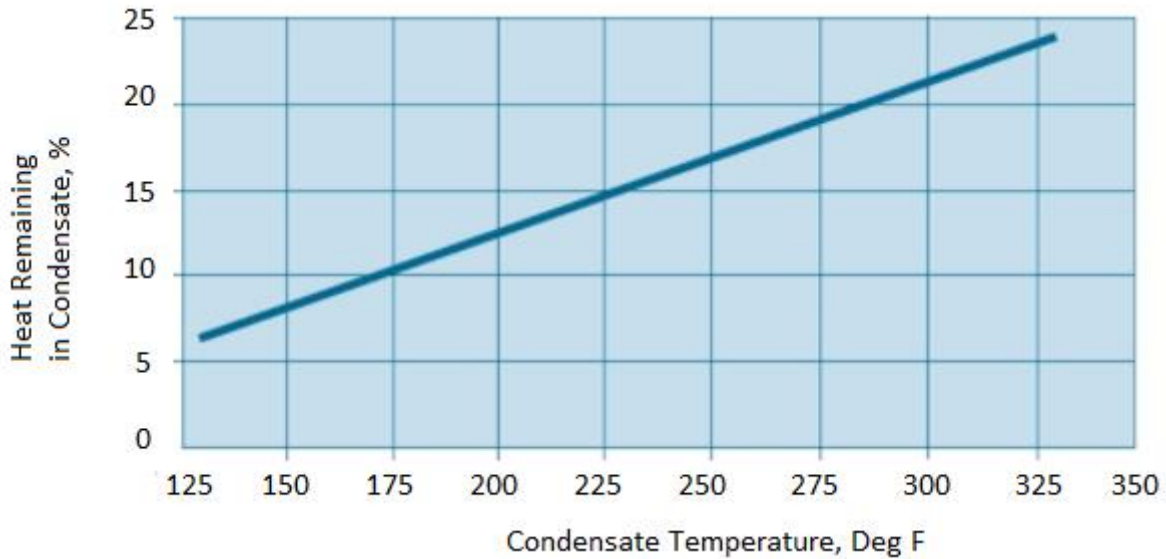

Consider:

h_c = Enthalpy of condensate at 180°F = 148 Btu/lb

h_m = Enthalpy of makeup water at 55°F = 23 Btu/lb

h_s = Enthalpy of steam at 100 psig = 1189 Btu/lb

$$\text{Heat remaining in condensate (\%)} = \frac{h_c - h_m}{h_s - h_m} \times 100 = \frac{148 - 23}{1189 - 23} \times 100 = 11\%$$

The return of condensate obviously has too many advantages that simply shouldn't be ignored. In this chapter, we will discuss Six (6) important aspects of effective steam utilization.

1. Efficiency Tip # 1: Right Application of Steam Traps
2. Efficiency Tip # 2: Implement an effective Steam-Trap Management
3. Efficiency Tip # 3: Maximize Thermal Energy of Condensate Recovery
4. Efficiency Tip # 4: Utilizing Low Pressure Flash Steam
5. Efficiency Tip # 5: Use flash steam in lieu of throttling high-pressure steam
6. Efficiency Tip # 6: Cover Heated Open Vessels

8.1 Condensate Recovery

Two common methods of condensate recovery are:



- a. Implement an effective steam-trap management
- b. Recover flash steam



8.2 Steam Traps

Steam traps are automatic valves that discharge condensate from a steam line without discharging steam. If the trap fails open, steam escapes into the condensate return pipe without being utilized in the process. If it fails closed, condensate fills the heat exchanger and chokes-off heat to process.

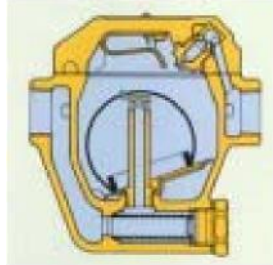
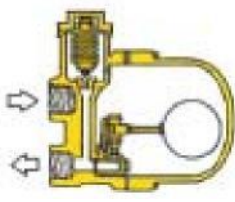
Several different types of steam trap technologies exist to accomplish this critical task. The most widely used rely on differences in temperature, specific gravities, and pressure.

Classification and Characteristic of Steam Trap

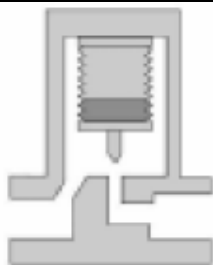
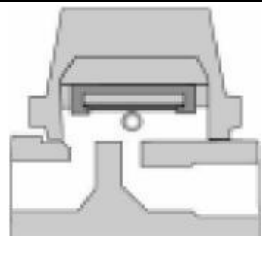
Mechanical Steam Trap			
Inverted bucket type	Free ball bucket type	Float with lever type	Free float type
			
<p>Principle: Mechanical traps work by using the differential of density between steam (gas phase) and hot condensate water (liquid phase). The on-off element inside steam trap will float up in condensate and sink in steam.</p>			

Thermostatic Steam Trap			
Bimetal type	Bellow type	Capsule type	X Element type
			

Principle: Thermostatic traps work by using the differential of temperature between steam and hot water. During condensation, the condensate temperature will be same as steam. After that, condensate temperature will decrease below steam temperature because of losses in pipe.

Thermodynamic Steam Trap

Impulse type

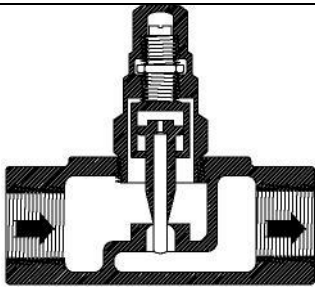

Disc type Air vent

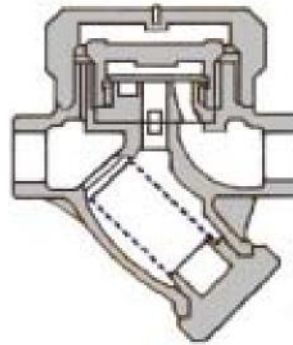

Disc type not Air vent

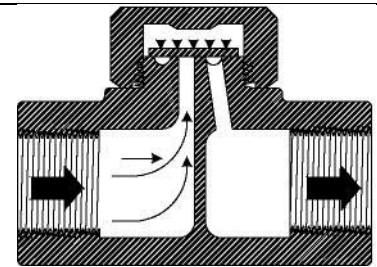

Principle: Thermodynamic traps work by using the differential of dynamic flow between steam and condensate. At the same differential pressure, the steam will flow through a pipe with higher velocity than condensate.

The table below shows the comparison of various steam traps.

Comparison of Common Steam Trap Properties

Working condition	Type of steam trap				
	Thermodynamic	Float	Bucket	Balance pressure	Bimetal
Pressure range (psi)	10-600	0-300	10- 2,700	0-600	0-3,000
Maximum capacity (lb/hr)	5,200	100,000	2,000	13,500	7,800
Discharge condensate temperature	Below saturation point	saturation	saturation	Below saturation point	According to adjusting
Condensate releasing	Open/close	continuous	Open/close	Semi continuous	Semi continuous

Working condition	Type of steam trap				
	Thermodynamic	Float	Bucket	Balance pressure	Bimetal
Gaseous releasing	good	Very good	Fairly good	Very good	Very good
Dust removal	Fairly good	good	good	Fairly good	good
Superheat suitability	Very good	unsatisfied	Fairly good	Fairly good	Very good
Water hammer durability	Very good	Fairly good	Very good	Fairly good	Very good
Load variability	good	Very good	good	good	Fairly good
Pressure variability	good	Very good	Fairly good	Fairly good	Fairly good
Inconvenient blocked up condition	open	close	open	uncertainly	open

8.2.1. Sizing Criteria of Steam Traps

- a. The trap should be sized to discharge condensate at peak rate. An insufficiently sized trap leads to banking-up of condensate, the inevitable consequences being water hammer and a reduction in the heating capacity.
- b. If the plant is operated with varying pressure (e.g. controlled plants), the capacity characteristics of the steam trap must be at least equal to that of the heat exchanger at the possible service pressures or, if possible, a little higher.
- c. The traps should not be considerably oversized either. They would then have a tendency towards overcontrolling, which may lead to water hammer through intermittent operation. This point must be considered particularly with thermodynamic disc-type traps and inverted-bucket traps.
- d. The steam trap should provide automatic air-venting during operation. Air in the steam space of the heat exchanger will prolong the heating-up period during plant start-up and reduce the heating capacity during normal operation.

8.3 Efficiency Tip # 1: Right Application of Steam Traps

Three important areas for steam trap applications are:

- a. Drip applications

- b. Process applications
- c. Heat tracing applications

8.3.1. Drip Applications

Drip Legs are used for removing condensate formed in steam lines when steam loses its heat energy due to radiation losses. Traps used for these applications require relatively small condensate capacities and don't normally need to discharge large amounts of air. (Note that air removal is the primary function of air vents and the process traps located throughout the system. Since condensate drains by gravity, drip legs must be located on the bottom of piping and designed with diameters large enough to promote the collection.

The most common trap choices for drip applications are thermodynamic traps for steam pressures over 30 psig, and float and thermostatic for pressures up to 30 psig. Inverted bucket traps are also commonly used for drip trap applications due to their ability to handle large amounts of dirt and scale often found in this type of application.

8.3.2. Process Applications

Process trap applications refer to removing condensate and air directly from a specific heat transfer process such as a heat exchanger that could be making hot water or a radiator heating a room. Traps used in these applications are referred to as process traps.

Traps used for process applications require larger condensate handling capability and need to be able to discharge large amounts of air. The most common trap choices for process applications are float and thermostatic traps. They are excellent at discharging air from the system during start-up and their design allows to immediately respond to changing condensate loads and pressures, which is a typical requirement of continuous heating process applications where control valves are used to modulate steam flow.

In contrast, thermodynamic traps, and inverted bucket traps, which have poor air handling ability, would normally make a poor choice for process applications.

8.3.3. Tracing Applications

Steam tracing refers to using steam to indirectly elevate the temperature of a product using jacketed pipes or tubing filled with steam. A typical application would be wrapping a pipeline containing high viscosity oil with tracing tubing. The steam inside the tubing heats the oil to lower its viscosity, allowing it to flow easily thru the pipeline.

A steam trap must be used on the end of the steam tubing to discharge unwanted condensate. Steam traps used in these applications are referred to as tracing traps. The most common trap choice for tracing applications is the thermostatic type.

8.3.4. How to Install Steam Trap Properly?

Correct installation of steam traps is a critical factor. Many times, a correctly sized and selected trap will also fail due to the wrong installation. Here are few best practices:

- a. The most important rule to remember for steam trap installation is GRAVITY. Condensate must flow from the process to the steam trap by the forces of gravity. Pressure and velocity cannot be relied on to remove the condensate from the process. To aid removal of condensate, steam lines should always be fitted at a slight downward angle in the direction of flow. As a rule, the minimum fall should be 1:100.
- b. Drip legs are the most important application in the steam lines. Drip legs should be located at bends in piping (direction changes), low points, end of the line, and in straight run of piping every 150 - 200 feet. For the protection of equipment such as regulators and control valves, drip legs should be installed directly ahead of the regulating or control valve line.

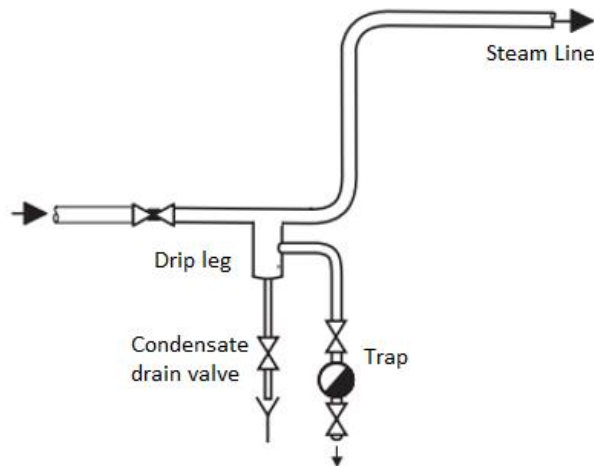

Because condensate drainage from steam systems is dependent upon gravity, drip leg diameter is critical for optimum removal – the larger the better. Collection leg diameter (DL) is recommended to be the same size as the steam main (D), up to 4". For steam mains above 4", the collection leg diameter may be half the diameter of the main, but not less than 4".

The length (L) of the drip leg should be a minimum of 2.3 feet (28") to provide a minimum of 1 PSI head pressure.

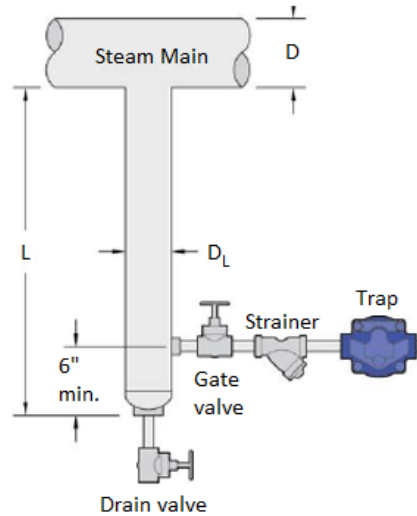

- c. Piping from the process to the steam trap should always be equal to or larger than the process outlet connection. For example, a steam unit heater with a 1" condensate outlet would have a 1" or larger tubing/piping from the unit heater to the same connection size on the steam trap. Never reduce the diameter of the tubing/piping before the steam trap or reduce the connection size of the steam trap.
- d. The pipework downstream of the steam trap should be adequately sized so that high backpressures do not build up because of flash steam. For example, 1-inch (connection) steam trap discharge tubing/piping should be increased to 1.5". This will allow the flash steam to expand and not cause back pressure on the steam trap.

- e. If the steam trap is discharging into the condensate return lines or against some back pressure, a non-return valve ($\frac{1}{4}$ psi opening pressure disc check valve) should be installed downstream of the steam trap to avoid the waterlogging due to negative pressure difference across the steam trap.
- f. An isolation valve and strainer should be installed before any steam trap. The isolation valve simplifies maintenance of the trap and the strainer protects the trap from any dirt,

debris or scale in the line. In case of thermodynamic steam traps or bucket traps, an inbuilt strainer is present which eliminates the need of installing a separate strainer. On the other hand, float type steam traps do not have an inbuilt strainer and hence, it is imperative to install a strainer upstream to avoid blockages and damages to the trap internals.

- g. The steam trap should be installed immediately before pressure reducing valves / control valves to prevent condensate from pooling when the valve is closed. The trap also helps reduce erosion of the valve seat from condensate. Similarly, traps are also generally installed between two pressure-reducing valves in a series installation to remove condensate trapped between the valves during operation or shut-off.
- h. Locate the steam trap below the lowest condensate discharge point of the equipment. Never install a rise in the pipe ahead of a steam trap.

The table below highlights the wrong and correct installation of the steam traps.

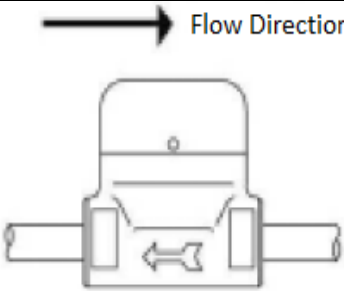
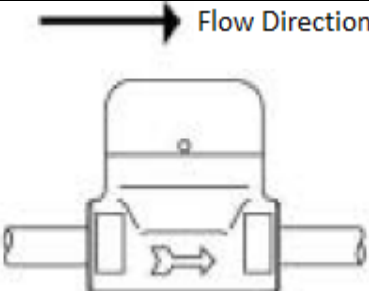
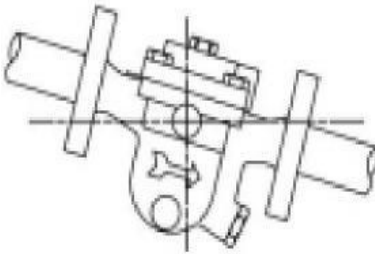
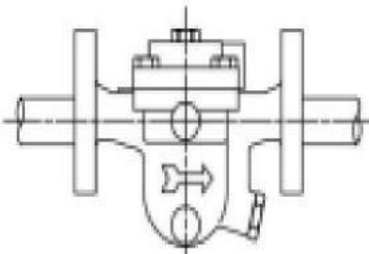
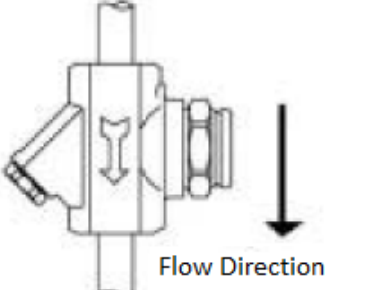
Wrong	Description	Correct
	<p>Steam trap should be filled in the direction of flow. All steam trap bear on the body steam or make showing flow direction.</p>	
	<p>Free float type steam trap should be fitted horizontally.</p>	
	<p>Thermodynamic steam trap has no limitation as to position. It can be fitted vertical.</p>	

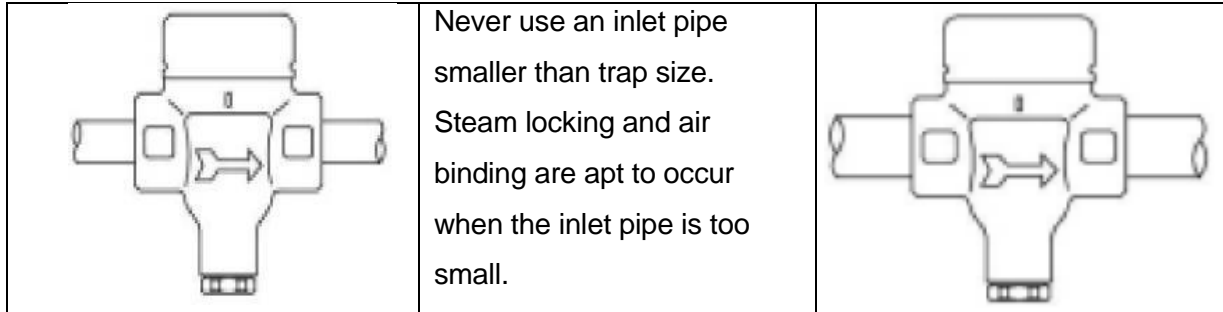

8.4 Efficiency Tip # 2: Implement an Effective Steam-Trap Management

Steam traps are designed to operate for about 10 years but can fail sooner due to contamination, improper application, and other reasons. Steam traps can fail “open” or “closed”. If a steam trap fails “open”, it allows steam to pass through the trap; hence the energy value of the steam is completely wasted. If a trap fails “closed”, condensate will back up into the piping or upstream equipment (which reduces steam flow, inhibits valve function, and causes pipe erosion) and/or flood the heat exchanger (which reduces or eliminates effective heat transfer). Because of these problems, it is recommended that all traps be tested at least once per year.

8.4.1. Testing and Maintenance of Steam Traps

Some tips for steam trap monitoring and maintenance are listed below:

- a. Flash steam and leaking steam are not the same. Leaking steam is continuous, like an exhaust, while flash steam is intermittent and like a cloud.
- b. Dirt, scale, or foreign material often damages the valve seat, preventing it from closing properly and leading to leakages. Strainers provided for handling dirt and other material before it reaches the traps must be maintained properly.
- c. Sight glasses, fitted after the traps, permit visual identification of blowing traps and need to be properly taken care of.
- d. Inverted bucket and thermodynamic traps should have intermittent condensate discharge. Float and thermostatic traps should have a continuous condensate discharge.
- e. A regular schedule of maintenance should be adopted, to repair and replace defective traps in the interest of fuel economy.

8.5 Efficiency Tip # 3: Maximize Thermal Energy of Condensate Recovery

A sizable portion (about 25%) of the total heat contained in the steam leaves the process equipment as condensate (hot water). The higher condensate return temperatures imply lesser heating required in the deaerator. This directly translates to steam and energy cost savings.

In large plants having extensive distribution of the steam system, the condensate recovery depends on the following factors:

- a. Contamination levels
- b. Cost of recovery equipment
- c. Cost of condensate piping

The biggest concern with the condensate recovery is the issue of flashing that could happen in the condensate return lines. This would lead to flow restrictions in the return piping and may cause water hammer issues. The problem can be magnified in a cascade system, where condensate from different locations is mixed and there are large temperature differences between the condensate returns. One solution to the problem is pumping condensate individually from each end-user but this will increase the complexity and project costs. Another solution is putting an adequate number of condensate receivers and flash tanks that can serve as a local collection point and reduce the amount of steam entering the condensate return piping.

The cost of recovery equipment and piping will depend on the physical location of the end-use compared to the boiler plant and the distance that condensate will have to be piped to get it to the boiler plant. Additionally, designs will have to consider electrically pumping condensate back versus using the steam pressure and a lift station.

8.5.1. Condensate Return Pipe Sizing

The accepted practice of determining condensate return pipe sizing is to base the size of the return pipe on the amount of flash steam in the return line. This is because the volume of flash steam is over 1,000 times greater than the equivalent volume of liquid condensate. Therefore, the flash steam is the dominant factor affecting flow in the return line.

Selection of condensate recovery piping size depend on amount of condensate per hour

Diameter, inches	Maximum volume (lbs./hr.)
1/2	350
3/4	800
1	1500
1-1/4	3300
1-1/2	5000
2	10000
2-1/2	20000

3	30000
4	63000

As a rule of thumb, the following velocity criteria should be followed:

- a. Velocity of Flash Steam in Condensate Return Lines should be between 4000 and 6000 ft/min.
- b. Velocity in Flash Tank should be less than 600 ft/min.
- c. Velocity in a Vent Pipe should be less than 4000 ft/min.

8.6 Efficiency Tip # 4: Utilizing Low Pressure Flash Steam

When the pressure of saturated condensate is reduced, a portion of the liquid “flashes” to low-pressure steam. Depending on the pressures involved, the flash steam contains approximately 10% to 40% of the energy content of the original condensate. In most cases, including condensate receivers and deaerators, the flashing steam is vented, and its energy content lost.

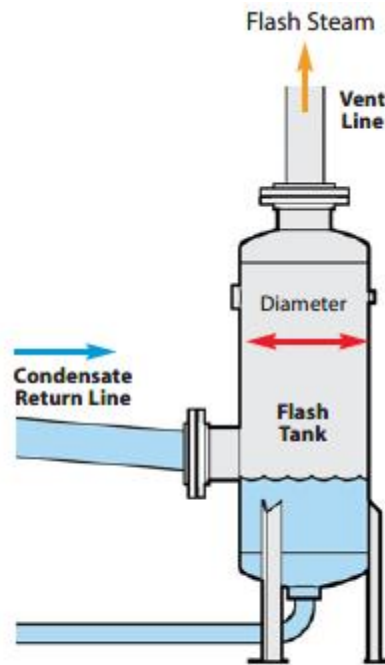

Flash Steam Arrangement

It is important to collect the flash steam in a specially designed heat exchanger or a vent condenser to recover the energy. A vent condenser could condense the flashed steam, transfer its thermal energy to incoming makeup water, and then return it to the boiler. Energy is recovered

in two forms: hotter makeup water and clean, distilled condensate ready for productive use in your operation.

A useful rule of thumb is that every 500 lb/hr of recovered flash steam provides 1 gallon per minute of distilled water.

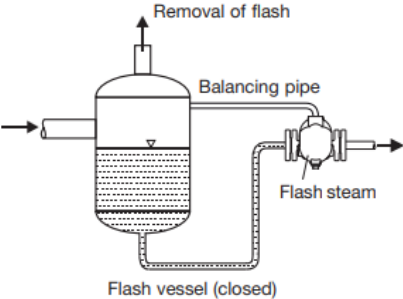
Wrong	Description	Correct
	As far as possible, the condensate should be collected and re-used in the closed flash vessel.	

The flash steam quantity can be calculated by the following formula with the help of steam tables:

$$\text{Flash steam is calculated in \%} = \frac{S1 - S2}{L2}$$

Where,

- S1 is the sensible heat of higher-pressure condensate
- S2 is the sensible heat of steam at lower pressure (at which it has been flashed)
- L2 is the latent heat of flash steam (at lower pressure)

Thus, the higher the condensate pressure, the greater is the quantity of flash steam that can be generated. Flash steam can be used on low-pressure applications like direct injection equipment and can replace an equal quantity of fresh steam that would otherwise be required.

Appropriate Flash tank volume

Flash tank volume			Condensate volume
Diameter mm	in	height mm	
150	6	940	900
200	8	940	2,250
300	12	1,000	4,500
380	15	1,100	9,000
460	18	1,200	13,000
500	20	1,400	16,000
600	24	1,400	20,000
760	30	1,400	34,000

920	36	1,500	50,000
-----	----	-------	--------

The steam system optimization strategy weighs the additional cost of dedicated high temperature condensate return compared to having a condensate receiver/flash tank (with an ambient vent) to remove this extra thermal energy. Depending on the amount of condensate, in many cases, flash steam from high-pressure equipment is made to use directly by the low-pressure equipment through pressure-reducing valves.

Example

When a steam trap passes condensate from the working pressure (130 psig) to the condensate system pressure (2 psig), the condensate contains excess energy above the liquid saturation level at the lower pressure. This excess energy causes some of the liquid to flash into steam. The percentage of flash steam to total liquid can be calculated by using the following formula:

$$\text{Percent Flash Steam} = \frac{hF1 - hF2}{hFG2} \times 100\%$$

where

- hF1 = Enthalpy (sensible) of condensate at Pressure P1, the inlet of steam trap
- hF2 = Enthalpy (sensible) of condensate at Pressure P2, the outlet of steam trap
- hFG2 = Enthalpy (latent) of flash steam at P2

For example:

P1 = 130 psig and P2 = 2 psig

hF1 = 328 Btu/lb

hF2 = 187 Btu/lb

hFG2 = 966 Btu/lb

$$\text{Percent flash steam @ 130 psig} = \frac{328 - 187}{966} \times 100 = 15\%$$

8.7 Efficiency Tip # 5: Use Flash Steam in Lieu of Throttling High Pressure Steam

Low-pressure process steam requirements are usually met by throttling high-pressure steam, but a portion of the process requirements can be achieved at low cost by flashing high-pressure condensate. Flashing is particularly attractive when it is not economically feasible to return the high-pressure condensate to the boiler. In the table below, the quantity of steam obtained per pound of condensate flashed is given as a function of both condensate and steam pressures.

High Pressure Condensate Flashing

High Pressure Condensate, psig	Percent of Condensate Flashed (lb Steam/lb condensate)			
	Low Pressure Steam, psig			
	50	30	15	5
200	10.4	12.8	15.2	17.3
150	7.8	10.3	12.7	14.9
100	4.6	7.1	7.6	9.9

The economics of this technique is most favorable when the source of high-pressure condensate is relatively close to the low-pressure steam usage to minimize piping and insulation costs.

8.8 Efficiency Tip # 6: Cover Heated Open Vessels

Open vessels that contain heated liquids often have high heat loss due to surface evaporation. Both energy and liquid losses are reduced by covering open vessels with insulated lids. The table below provides an estimate of the evaporative heat loss per square foot of uncovered vessel surface area for various water and dry ambient air temperatures. It is assumed that the ambient air is dry with no wind currents. A fan pulling air over the uncovered tank could more than double the heat losses.

Evaporative Heat Loss from the hot liquid in Open Tanks, Btu/hr-ft²

Liquid Temperature, °F	Ambient Air Temperature, °F				
	65	75	85	95	105
110	244	222	200	177	152
130	479	452	425	397	369
150	889	856	822	788	754
170	1608	1566	1524	1482	1440

Summary

There is considerable opportunity for energy efficiency improvement in industrial steam systems. Typical ways to increase steam system efficiency are:

Generation

- a. Install heat recovery; heat loss from flue gas usually holds the greatest energy saving potential (flue heat can be recovered using an economizer or pre-heater).
- b. Minimize excess combustion air. Measure excess O₂ in the boiler flue gases and trim the air/fuel ratio to the minimum acceptable excess combustion air amount to minimize the stack losses.
- c. Invest in boiler management control systems to chart boiler efficiency in relation to produced steam (e.g. monthly).
- d. Use digital combustion controls to optimize operations and save energy.
- e. Invest in variable speed drives for combustion air fans and coolant pumps to reduce energy consumption; even small reductions in speed can lead to significant savings.
- f. Control boiler fouling which can raise flue gas temperatures; the ratio of flue gas temperature and steam production indicates when to clean the boiler.
- g. Minimize boiler blowdowns to better control and recover heat from the blowdown water.
- h. Improve water treatment to minimize boiler blowdown.

Distribution

- a. Identify and repair steam leaks.
- b. Minimize vented steam.
- c. Check for gaps in insulation in piping and the steam network; thermal bridges, especially at fittings and valves, are a particular problem.
- d. Pay attention to condensation and frictional resistance within the pipework system; pressure loss should be considered during the design phase of a pipework system and the decision on the initial distribution pressure.
- e. Isolate steam from unused lines.

End-Use

- a. Optimize condensate recovery
- b. Use high-pressure condensate to make low-pressure steam
- c. Implement a steam-trap maintenance program
- d. Examine opportunities for reintroducing flash steam which can be recovered for low-pressure steam applications.

The general rules for efficient steam generation, distribution and use are:

1. **Boiler Rule 1.** Effective boiler load management techniques, such as operating on high fire settings or installing smaller boilers can save over 7% of a typical facility's total energy use with average simple payback of less than 2 years.
2. **Boiler Rule 2.** Load management measures, including optimal matching of boiler size and boiler load, can save as much as 50% of a boiler's fuel use.
3. **Boiler Rule 3.** An upgraded boiler maintenance program including optimizing air-to-fuel ratio, burner maintenance, and tube cleaning can save about 2% of a facility's total energy use with an average simply payback of 5 months.
4. **Boiler Rule 4.** A comprehensive tune-up with precision testing equipment to detect and correct excess air losses, smoking, unburned fuel losses, sooting, and high stack temperatures can result in boiler fuel savings of 2% to 20%.
5. **Boiler Rule 5.** A 3% decrease in flue gas O₂ typically produces boiler fuel savings of 2%.
6. **Boiler Rule 6.** Every 40°F reduction in net stack temperature (outlet temperature minus inlet combustion air temperature is estimated to save 1% to 2% of a boiler's fuel use.
7. **Boiler Rule 7.** Removing a 1/32-inch deposit on boiler heat transfer surfaces can decrease a boiler's fuel use by 2%; removal of a 1/8 inch deposit can decrease boiler fuel use by over 8%.
8. **Boiler Rule 8.** For every 11°F that the entering feedwater temperature is increased, the boiler's fuel use is reduced by 1%.

References

1. Improving Steam System Performance, A Sourcebook for Industry, U.S. Department of Energy, 2004.
<https://www.nrel.gov/docs/fy02osti/31797.pdf>
2. Manual for Industrial Steam Systems Assessment and Optimization
<https://www.unido.org/sites/default/files/2017-11/SSO-Manual-Print-FINAL-20161109-One-Page-V2.pdf>
3. Increasing the Energy Efficiency of Boiler and Heater Installations
<https://www.nrcan.gc.ca/energy/publications/efficiency/industrial/cipec/6699>